

ISBN 975-424-390-5

Müzik Ağıştırmaları

4 yaş ve üstü için



YA-PA YAYIN PAZARLAMA SANAYİ VE TİCARET A.Ş.
Cağaloğlu Yokuşu, Narlıbahçe Sok. No:11 34410 Cağaloğlu-İST.
Tel: (0-212) 511 86 36 - 511 34 05 Fax: 512 37 25



Mahiye Morgül'ün kitabındaki müzik alıştırmaları yazara haber vermeden alınıp ayrı olarak basılmıştır.

Değerli ana - babalar ve eğitimciler;

Bu kitap, Çocukluk Çağı Müzik Eğitimi (Yaratıcı Drama ile) adlı kitabımızın paralelinde, 4-6 yaş çocuklarına uygulanmak üzere, Yayınevimiz tarafından hazırlanmıştır.

Müzik, çocuğun kişilik gelişiminde ve sosyalleşmesinde etkin, önemli bir iletişim aracıdır. Okulöncesi dönemde çeşitli sesleri dinleme, tekrarlama, benzer ve farklı sesleri ayırtma deneyimleri, çocuk için çok yararlıdır. Bu kitapta, çocuğa, çalgıları tanıma-ayırma; sesleri dinleme-ayırma ile ilgili deneyimler kazandıracak çeşitli alıştırmalar sunulmaktadır.

Kitaptaki alıştırmalar, basitten karmaşığa doğru bir sıra izlemektedir. Her alıştırma ile ilgili yönerge, sayfalarda belirtilmiştir. Yönergeleri yazıldığı gibi okumak, bu yaş grubu için yeterlidir. Kitabı kullanmaya başlamadan önce, çocuğa boya kalemlerini hazırlaması söylenir.

YA-PA Yayın Pazarlama Sanayi Ticaret A.Ş.

Sevgili aileler,
1996'da basılmış olan bu kitabımı YA-PA tekrar basmama kararı almıştı ve dosyayı iade etmişti. Kitabımı geliştirmiş baskı olarak KÖK yayıncılık basmıştır; "ilk çocuklukta müzik nasıl öğretilir" adlı kitabım odur.

Haziran 2012 - Ankara
Mahiye Morgül
Morgül

EZGİ ÇALGILARI

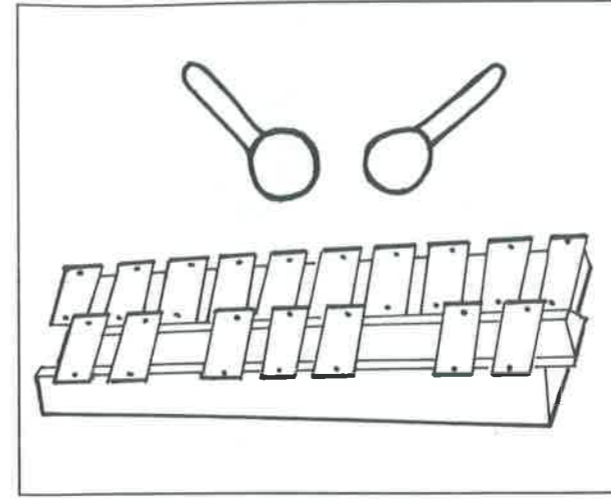

Metalofon

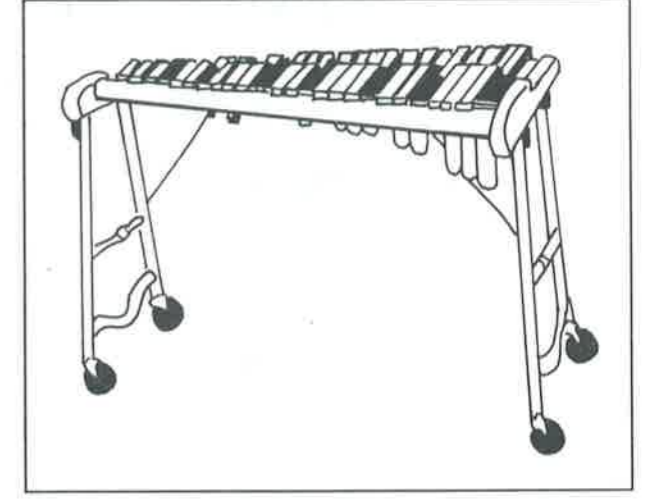

Ksilofon



Kaval



Mandolin



Flüt

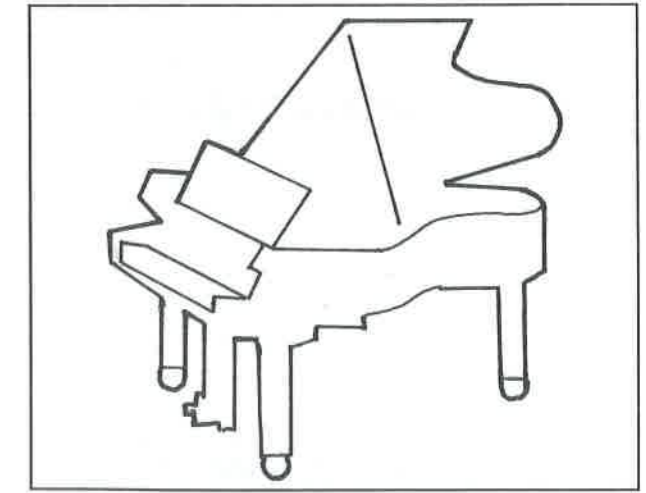

Piyano

Her çalgının adını söyle ve boya.



Gitar

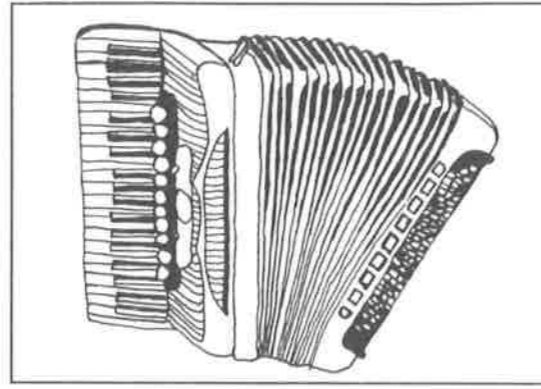

Akordion

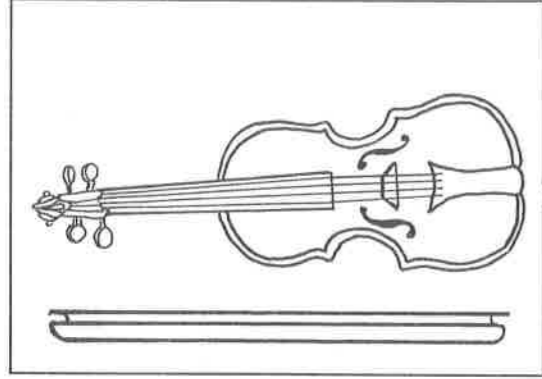

Keman

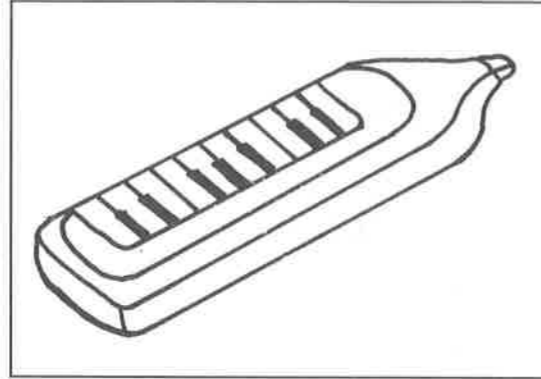

Melodika

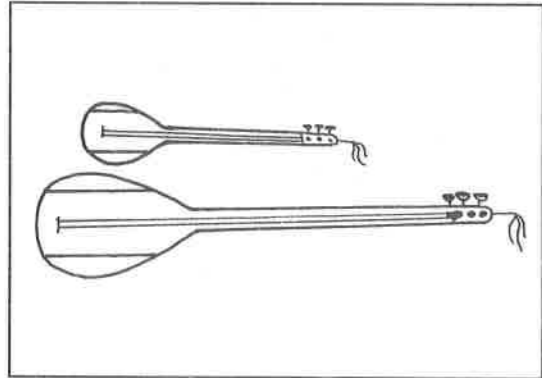

Cura ve Bağlama

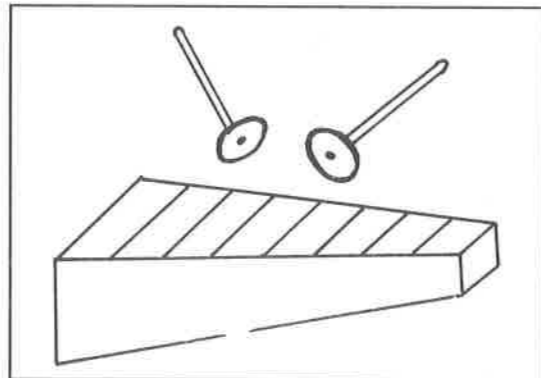

Bas Metalofon

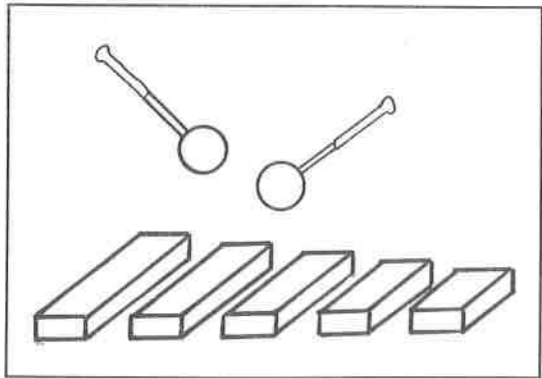

Tek Ses Kutuları

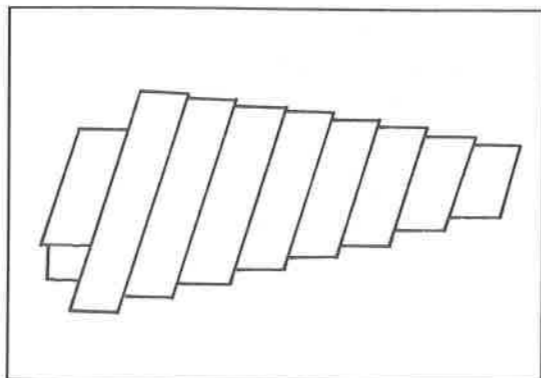

Çın-çın Metalofon

Her çalgının adını söyle ve boya.

RİTMİK EŞLİK ÇALGILARI (VURMALI ÇALGILAR)



Ağaç Blok

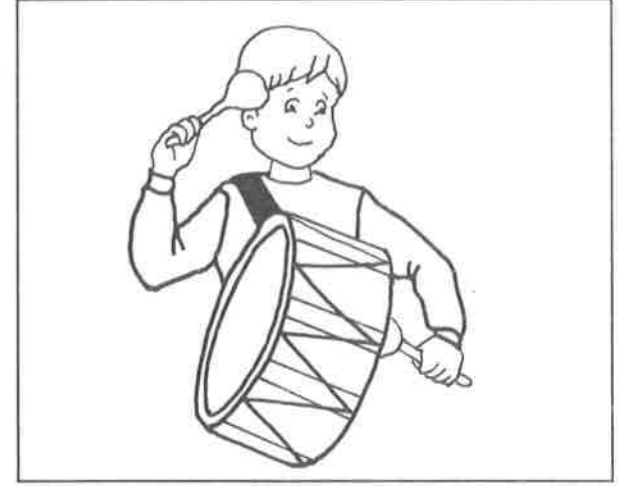

Davul



Havan

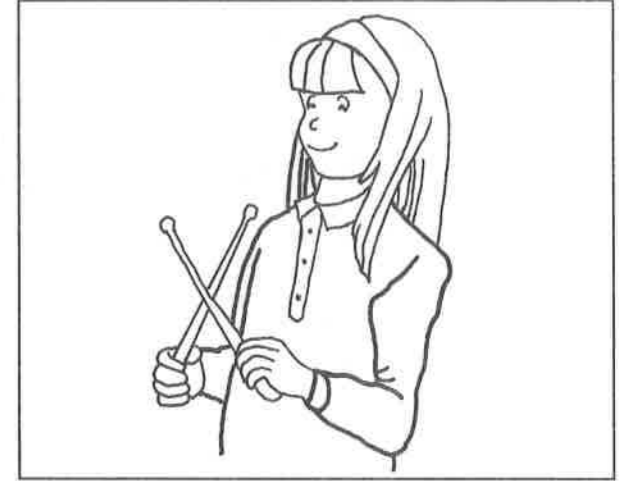

Baget



Deve Çanları

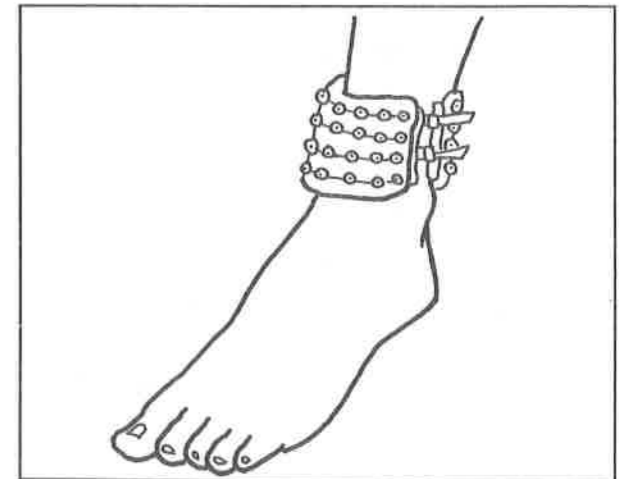

Halhal

Her çalgının adını söyle ve boya.

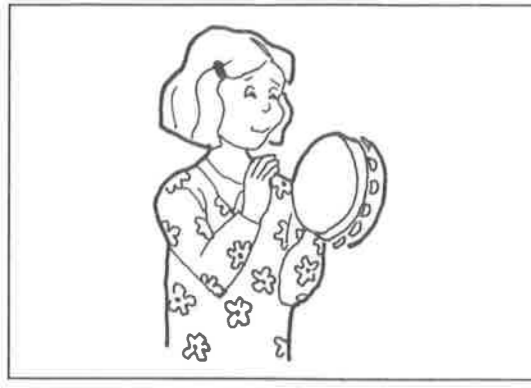

Tef



Çan

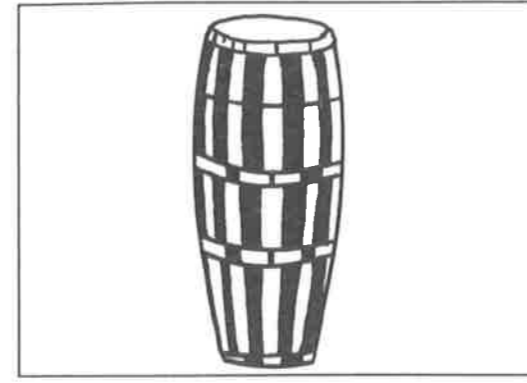

Konga



Çelik Üçgen



Tam-Tam

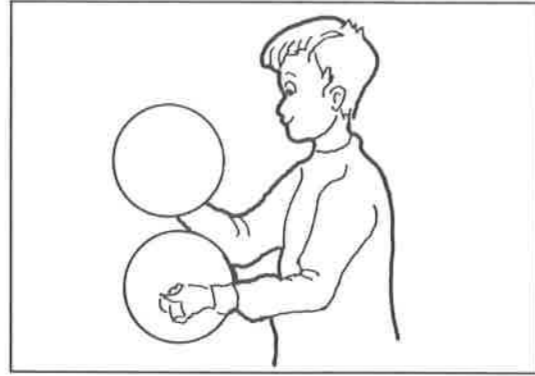

El Zili

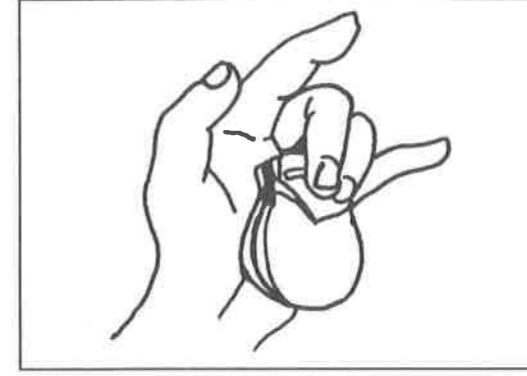

Kastanyet



Trampet

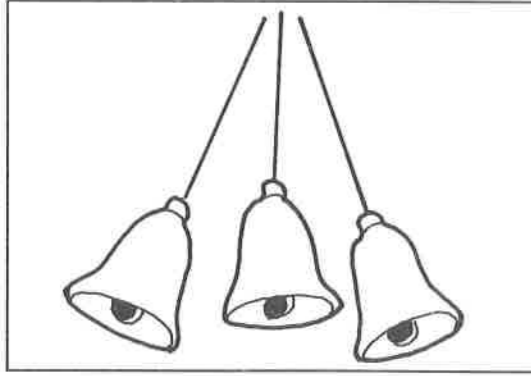

Koyun Çanları



Bongo

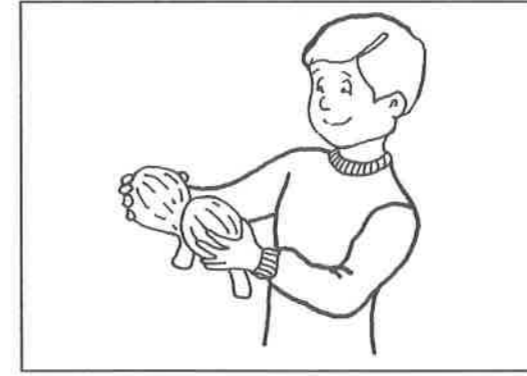

Su Kabağı

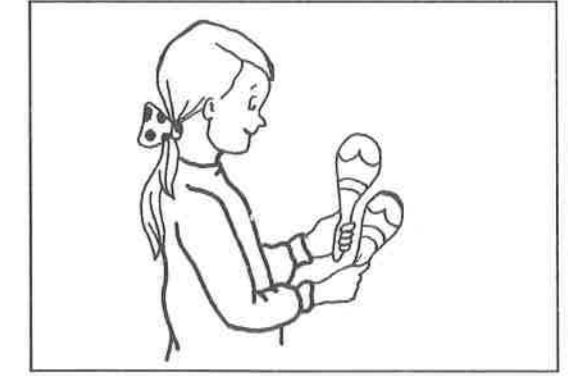

Marakas



Parmak Zili

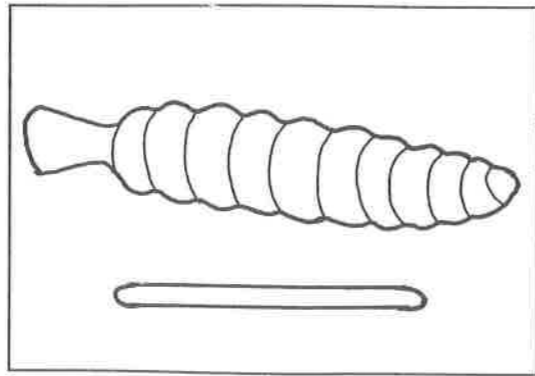

Tır-tır

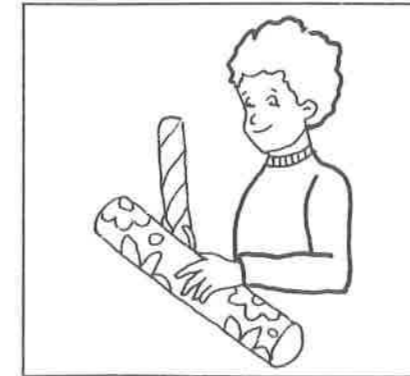

Boş Kutular

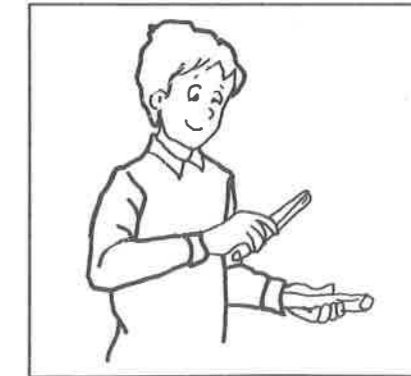

Ağaç Blok



Ağaç Blok

Her çalgının adını söyle ve boya.

Her çalgının adını söyle ve boya.

TEST: 1

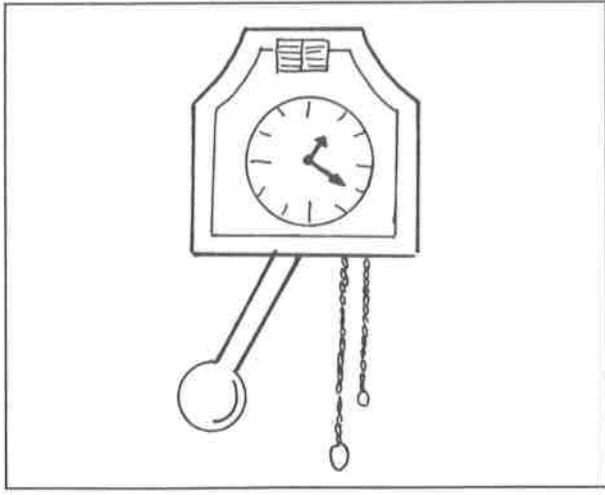

Sarkaçlı duvar saati

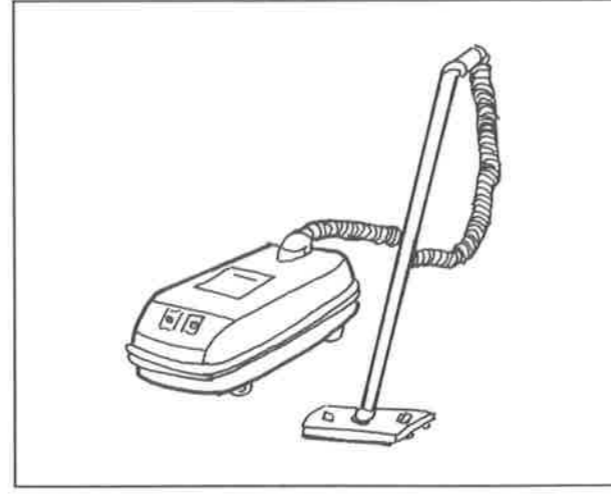

Elektrik süpürgesi

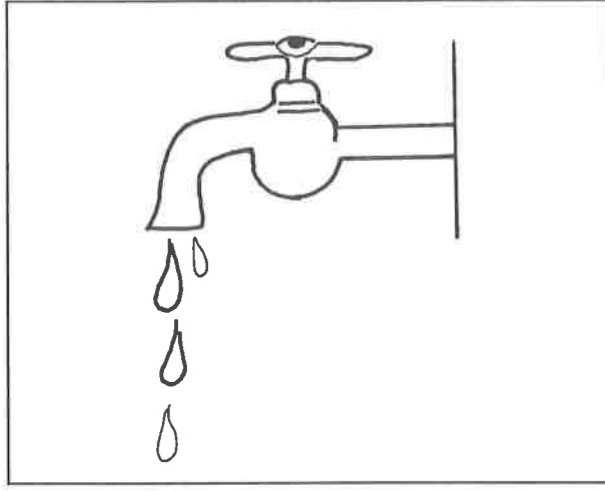

Su damlayan musluk

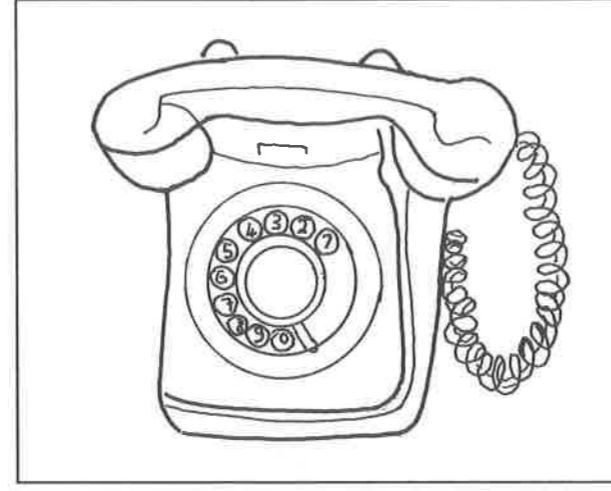

Telefon

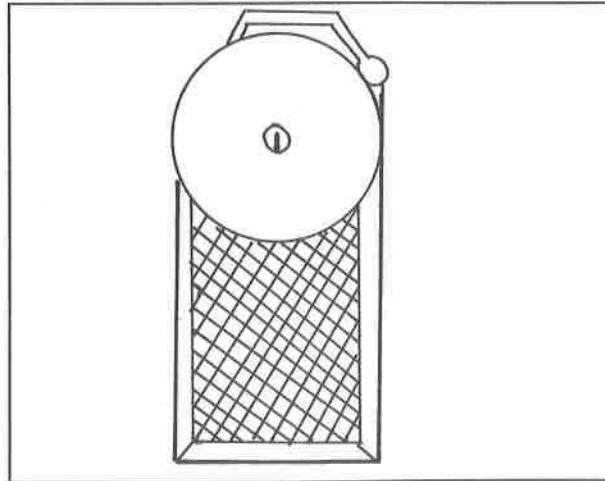

Kapı zili



Havan

Şimdi beni dinle. Çıkarttığım ses, hangi aracın sesine benziyor? O aracı göster ve adını söyle. (Sayfadaki her araç için, bu yönerge kullanılır. Ardından sayfa boyatılır.)

TEST: 2



Bongo



Parmak zili

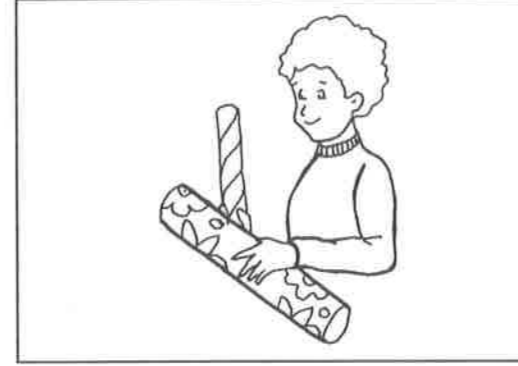

Ritm kutusu



Tef

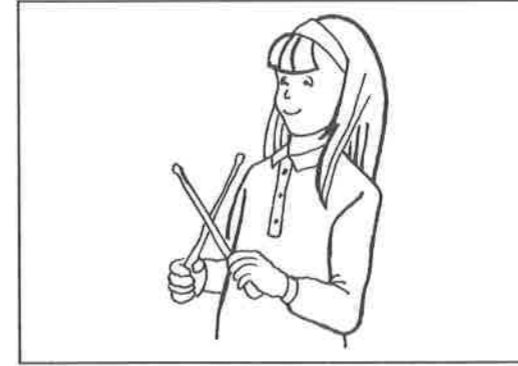

Baget

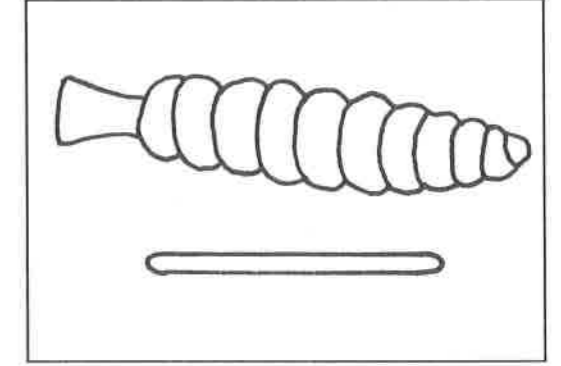

Tırır



Çelik üçgen

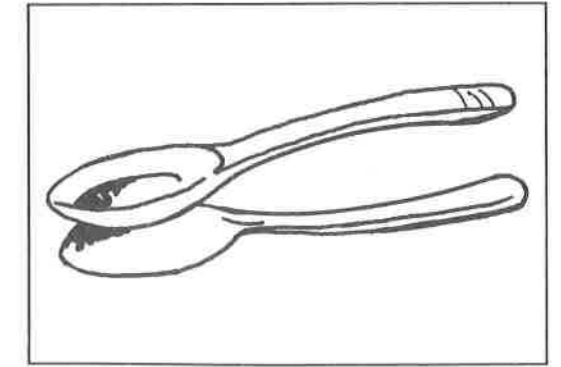

Kaşık

(Yetişkin, bir pano arkasında bir ritm aletini çalar.) Şimdi beni dinle. Hangi ritm aletini çalıyorum? O aleti göster ve boya.

TEST: 2

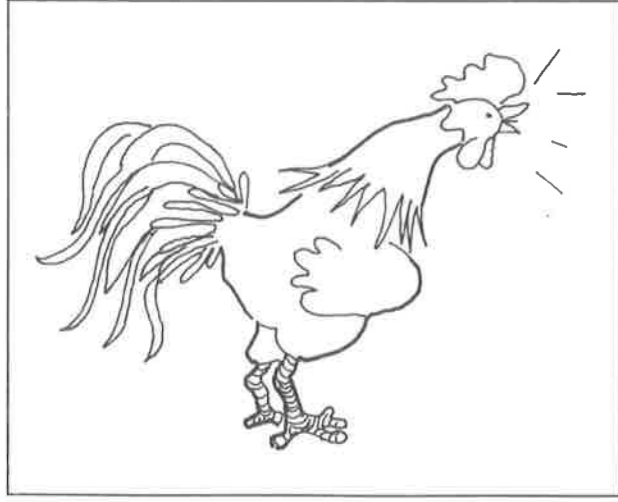

Horoz

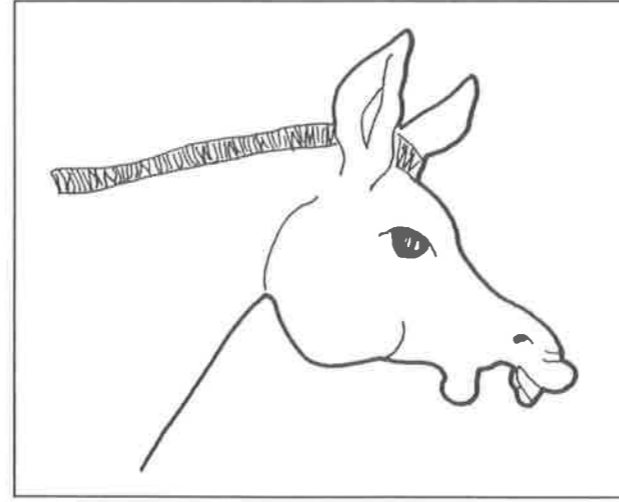

Eşek

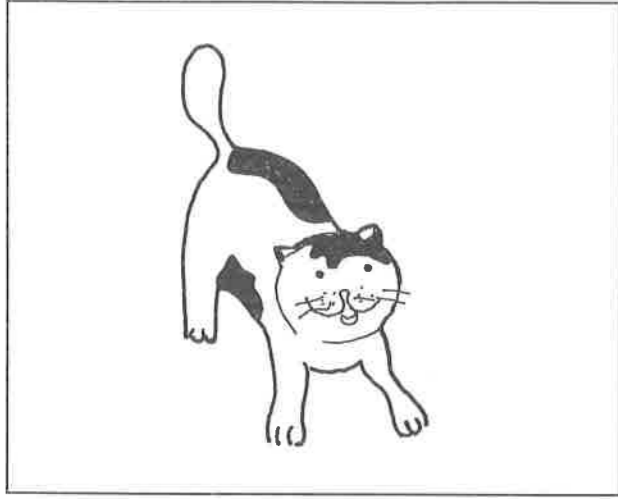

Kedi

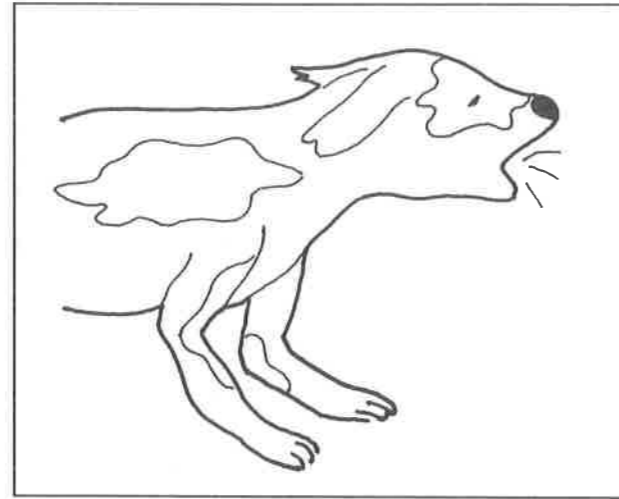

Köpek

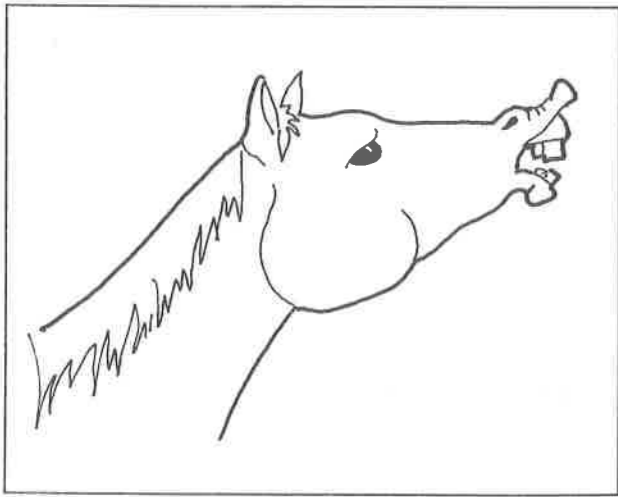

At

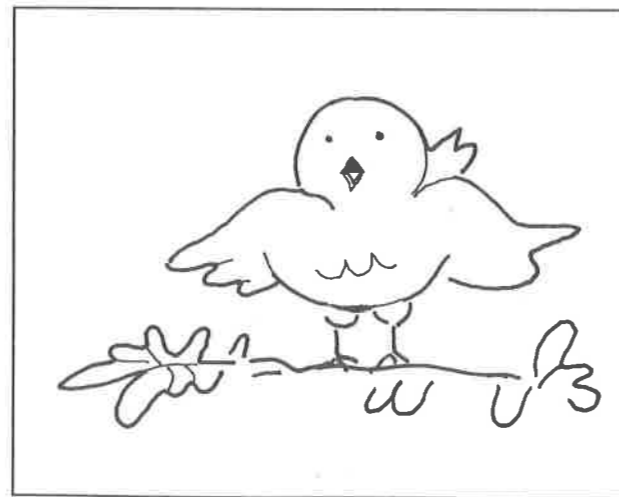

Kuş

Beni dinle. Hangi hayvanı taklit ediyorum? O hayvanı X işareti ile göster.
(Yetişkin, sayfadaki her hayvanı taklit eder ve aynı yönergeyi kullanır.)

TEST: 3

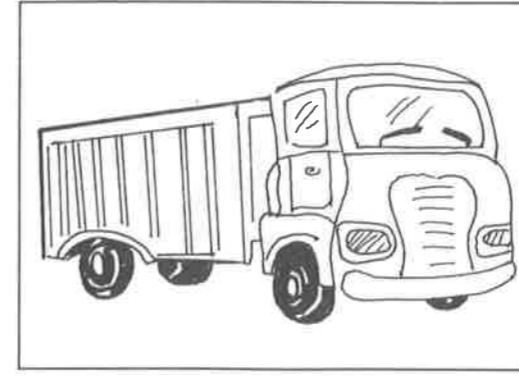

Kamyon

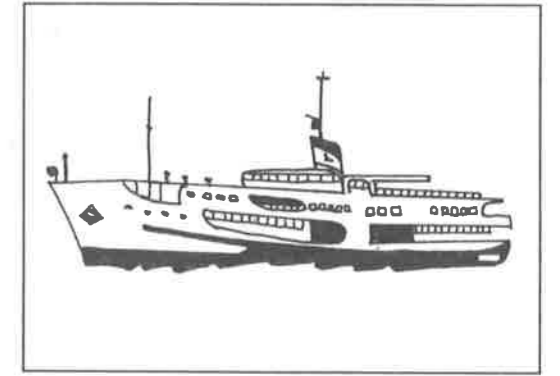

Vapur

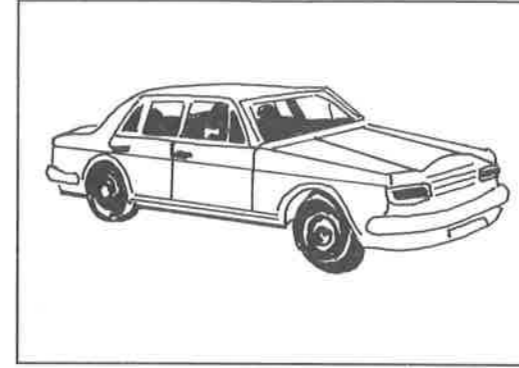

Araba

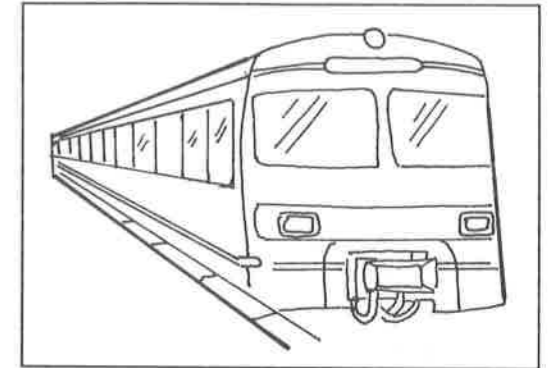

Tren

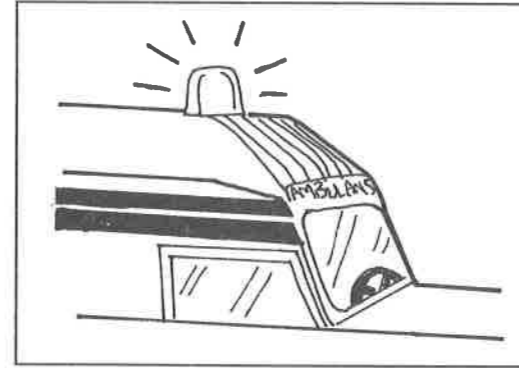

Ambulans

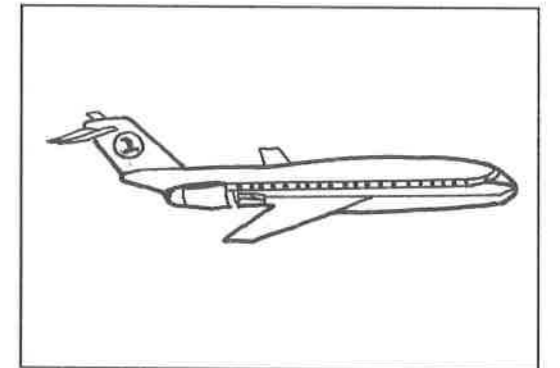

Uçak

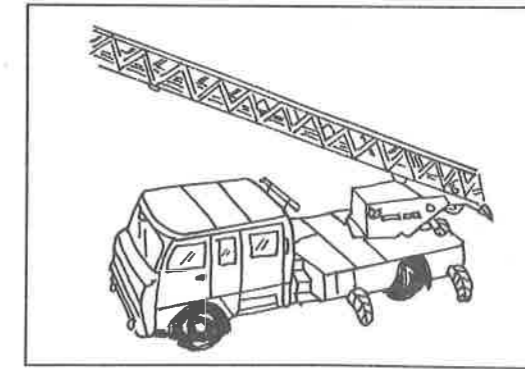

İtfaiye arabası

Beni dinle. Hangi taşıtın sesini taklit ediyorum. O taşıtı göster ve boya.
(Yetişkin, sayfadaki her aracın sesini taklit eder ve aynı yönergeyi kullanır.)

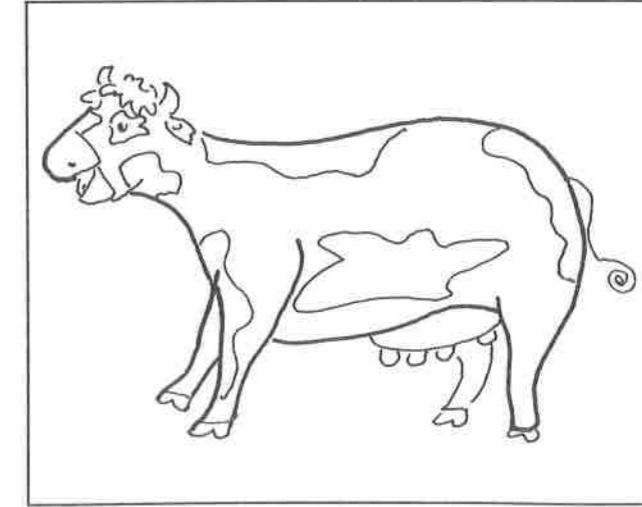
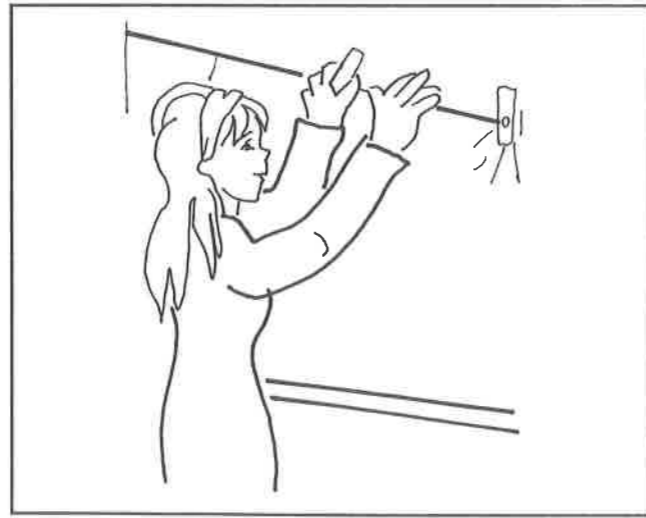
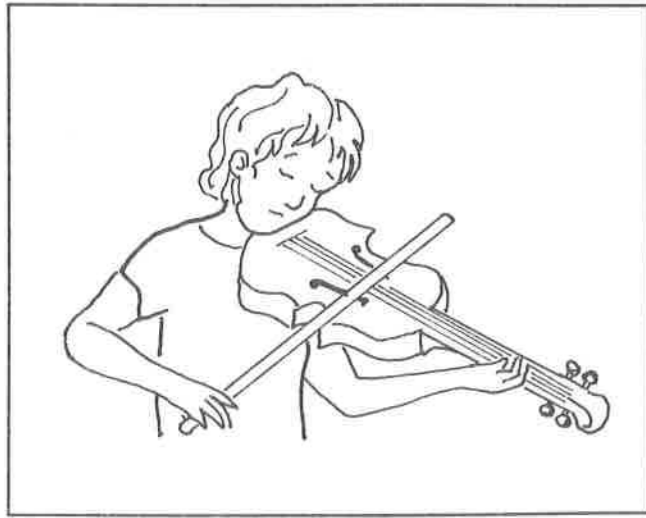
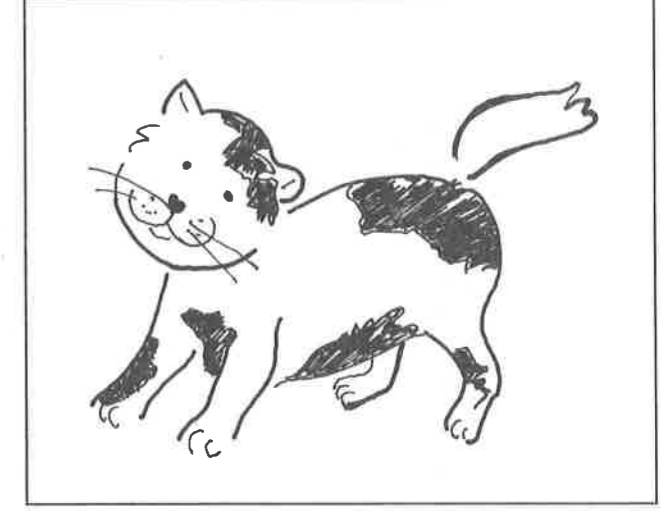
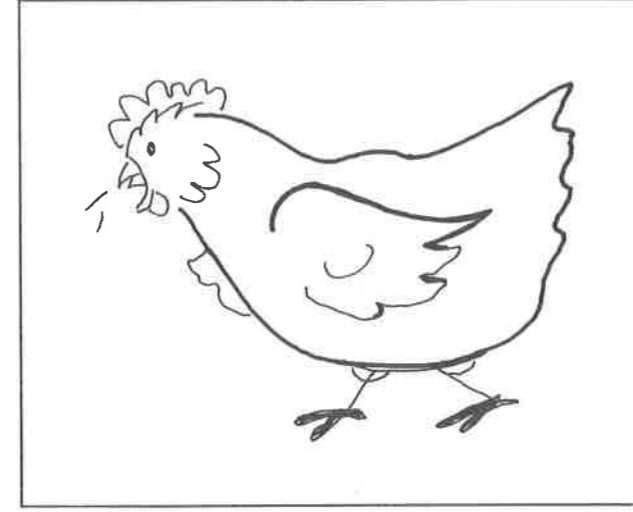
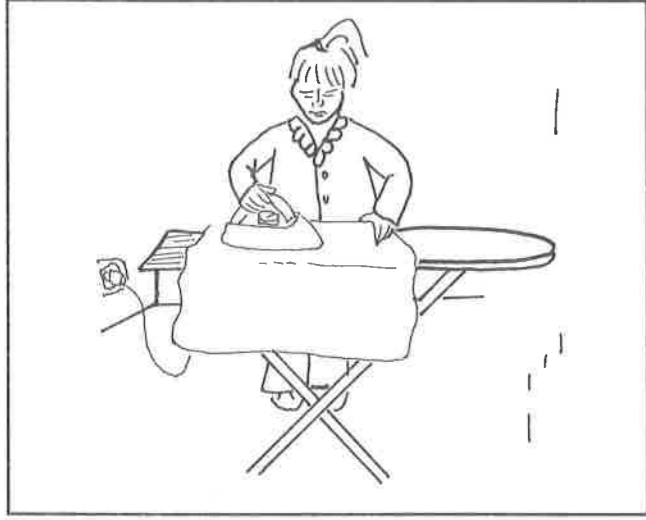
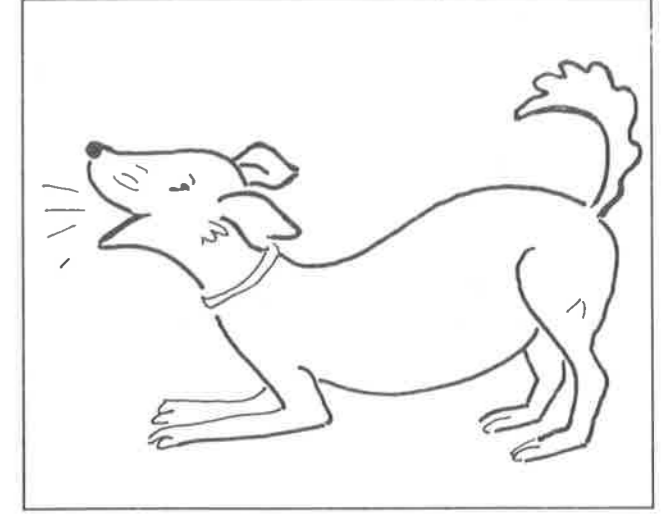
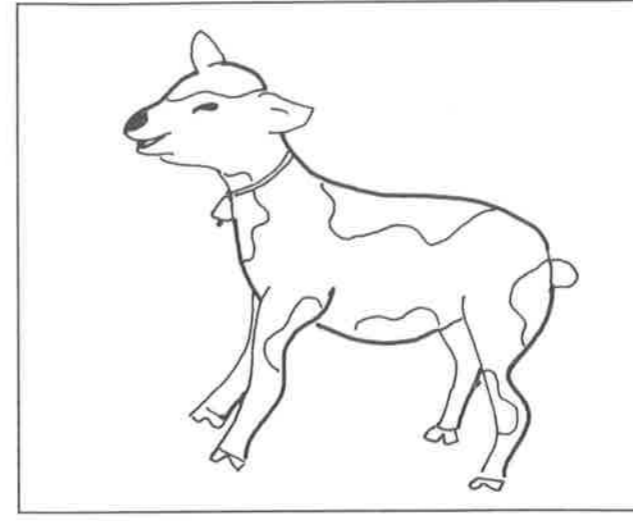

(Çocuğa altı renk kalem verilir.) Bango çalan çocuğu mavi renge boya. Ütü yapan çocuğu sarı kalemle boya. (Her çocuk için farklı renkte kalem kullanılır.)

Yetişkin, sayfadaki hayvanlardan birini seçip, aklında tutmasını çocuktan ister. Ardından, çocuğun hayvanı tanımlayacağı biçimde sorular yönelir. "Senin kaç ayağın var? Senin etini yer miyiz? Sen bize ne verirsin? Sen nasıl ses çıkartırsın?"

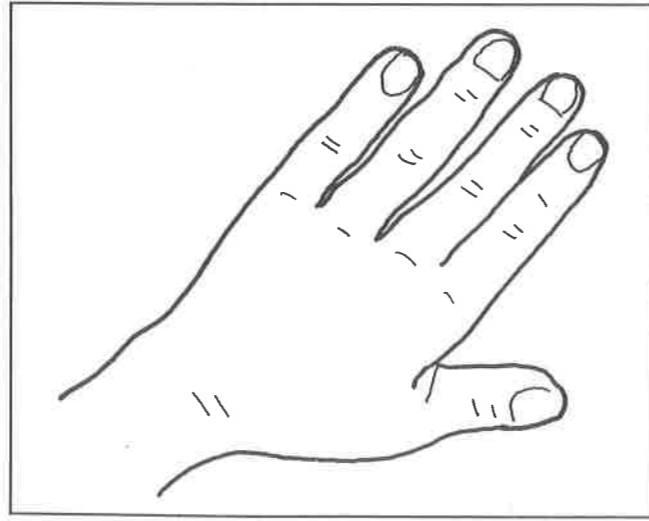
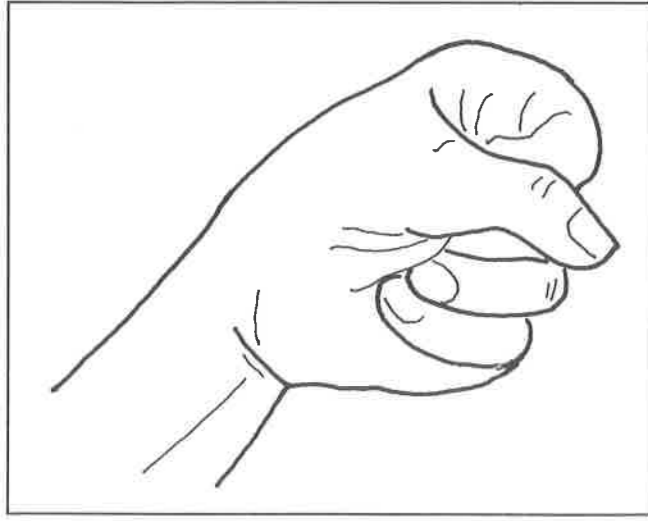
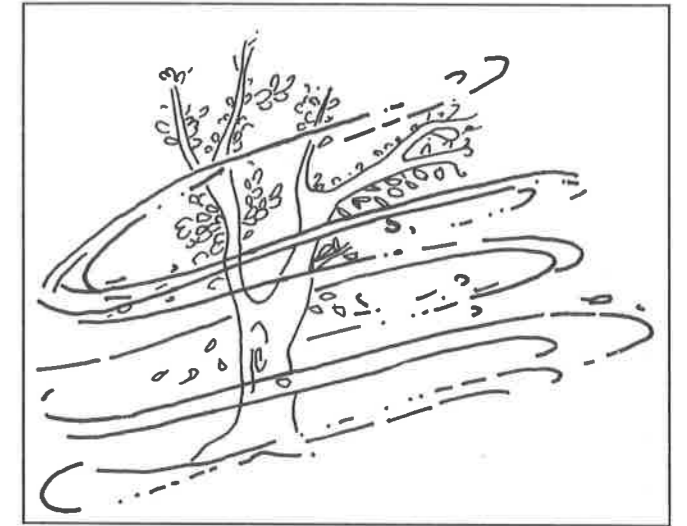
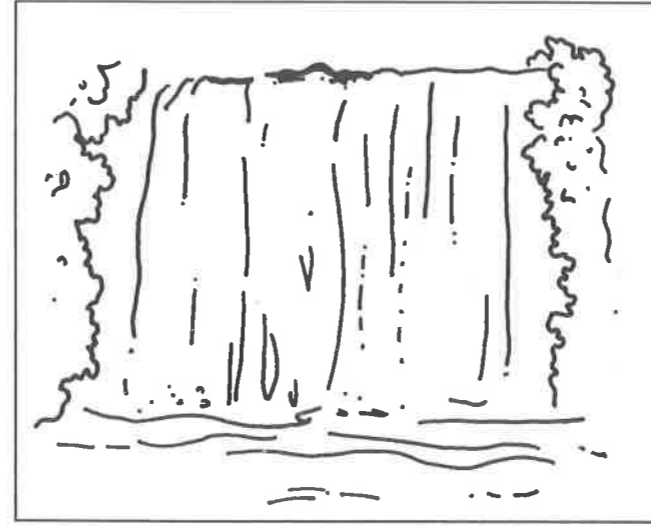
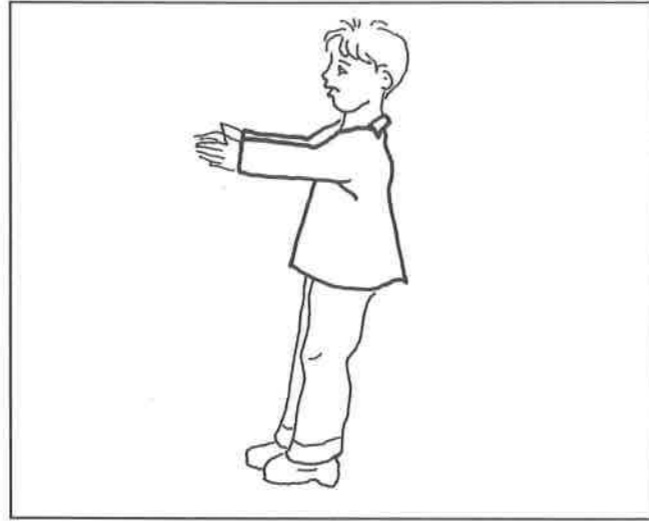
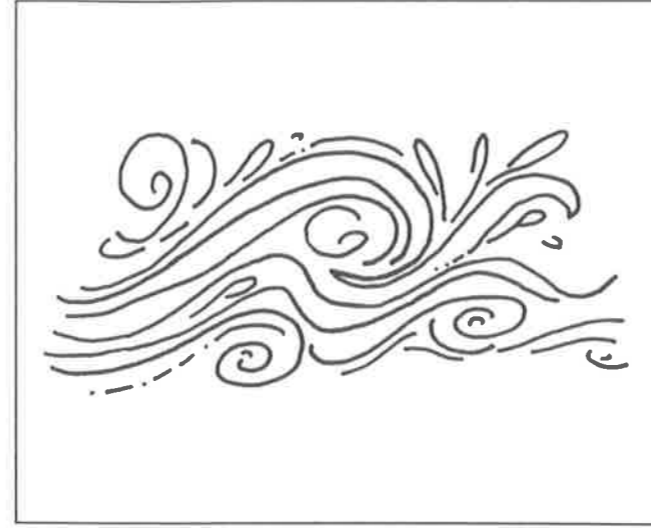
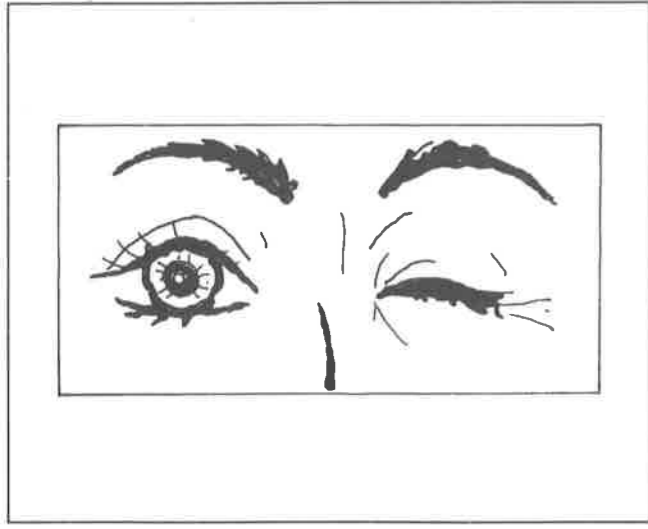

(Yetişkin, Yaratıcı Drama ile Oynayarak Yaşayarak Öğren adlı rehber kitabın 66.sayfasındaki "Gözlerimi Yumarım" şarkısının bir sözünü söyler.) Söylediğim söze uygun hareketi göster ve resmini boya.

(Kasetten doğa sesleri -yağmur, gök gürültüsü, fırtına, rüzgar vb. - dinletilir.) Dinlediğin bu ses, ne sesi? Resmini bul, göster ve resmi boya.

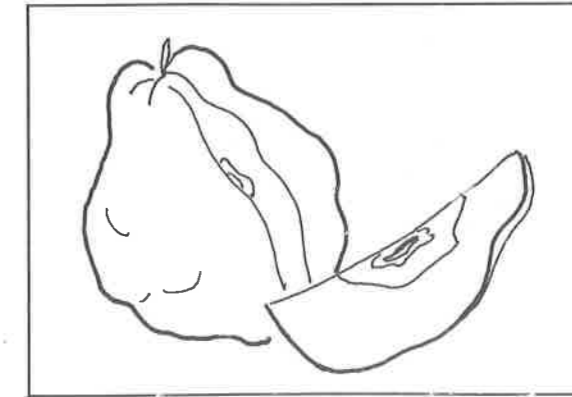
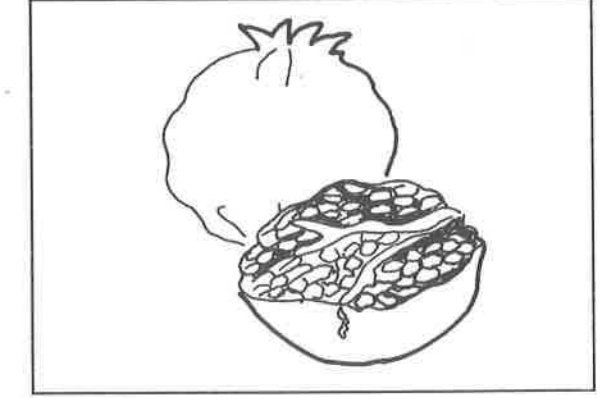
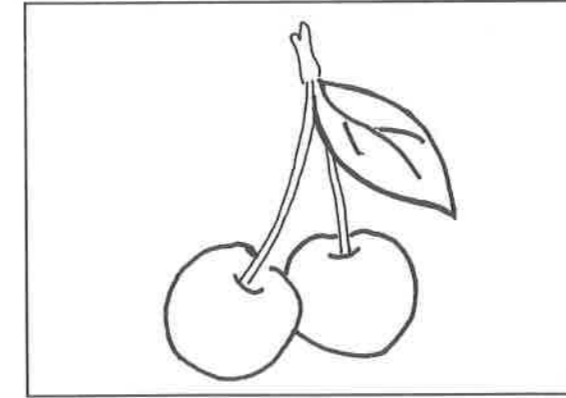
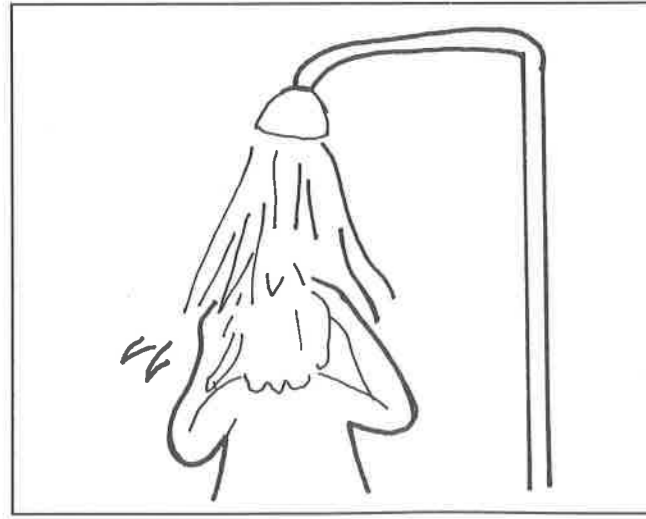
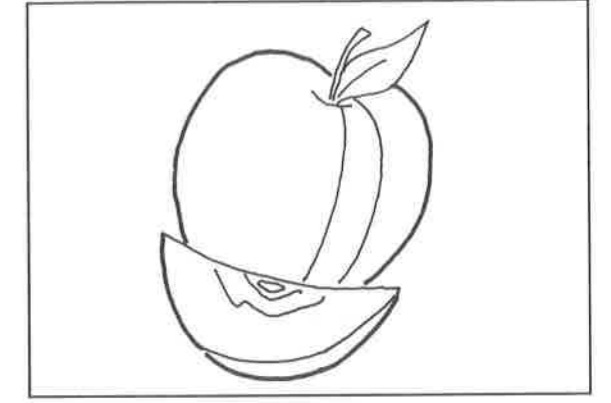
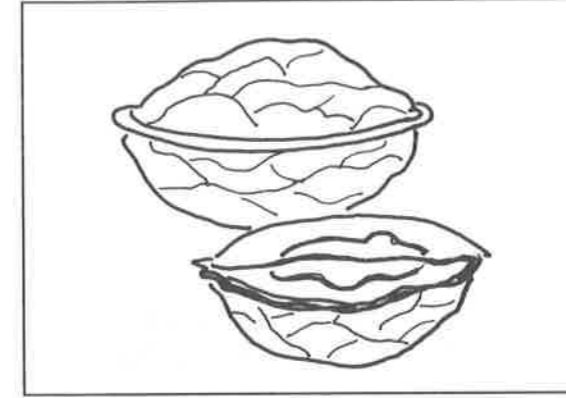
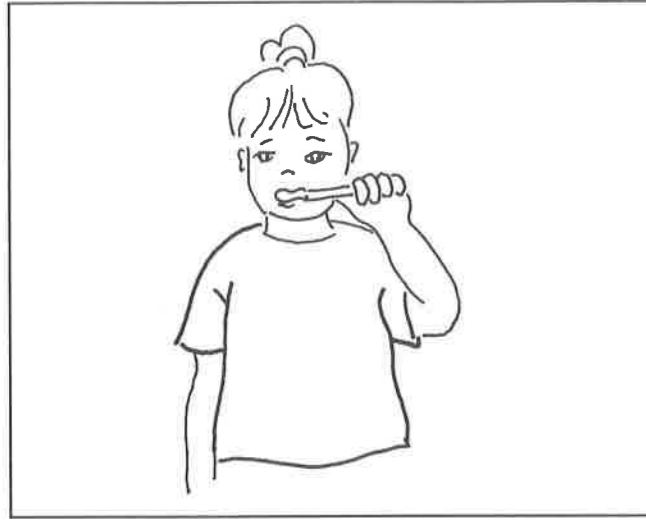
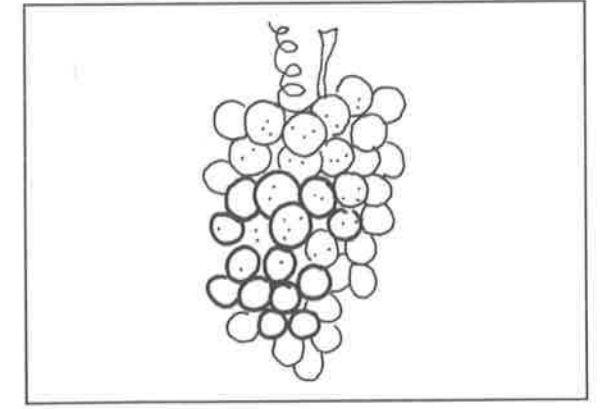
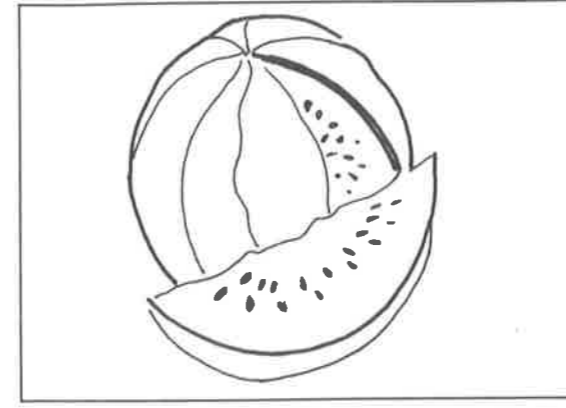
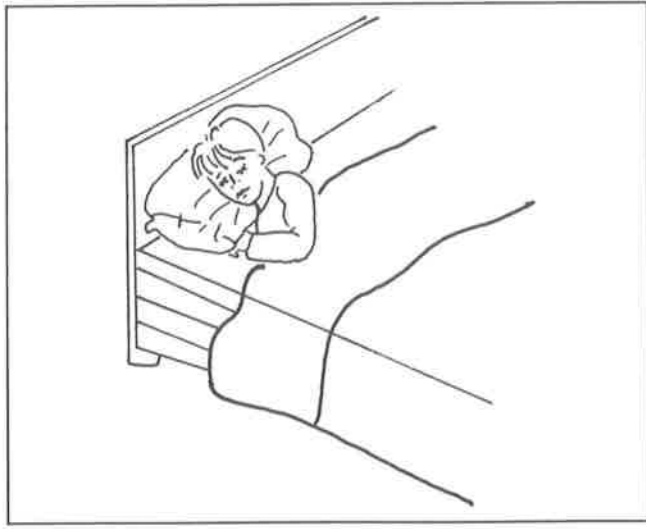

(Yetişkin, sayfadaki resimlerden birini gösterir.) Bu resimdeki çocuk ne yapıyor?
Bu işi yaparken çıkan sesi çıkart.

(S.85'teki Bir Karpuz Aldım Çarşıdan adlı şarkı söylenir.) Şarkısını dinlediğin
meyveyi göster. Sonra da sayfadaki meyveleri boya.

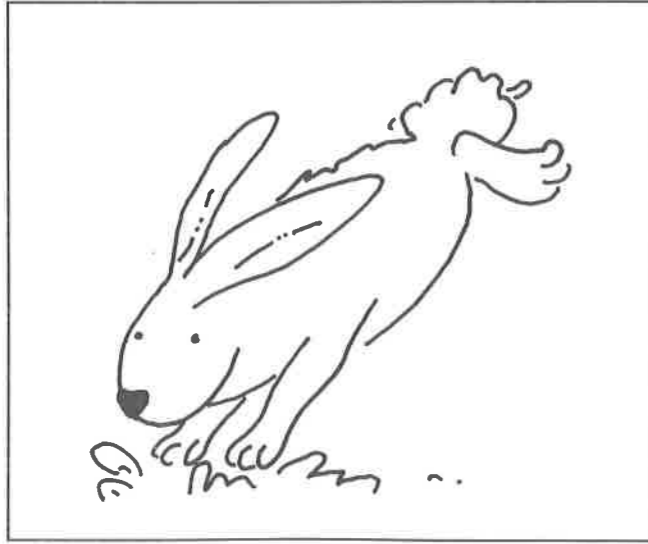
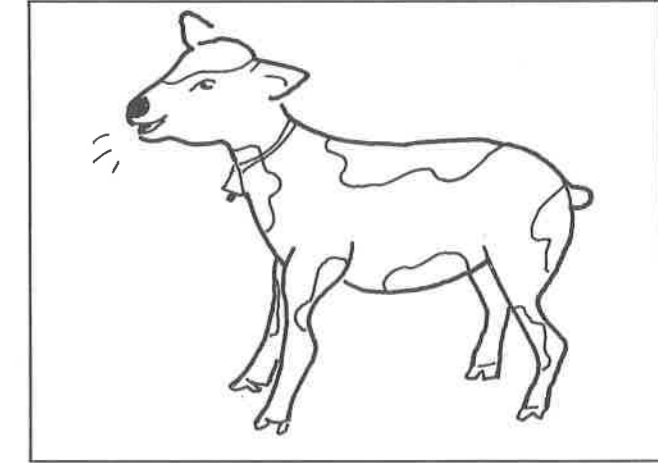
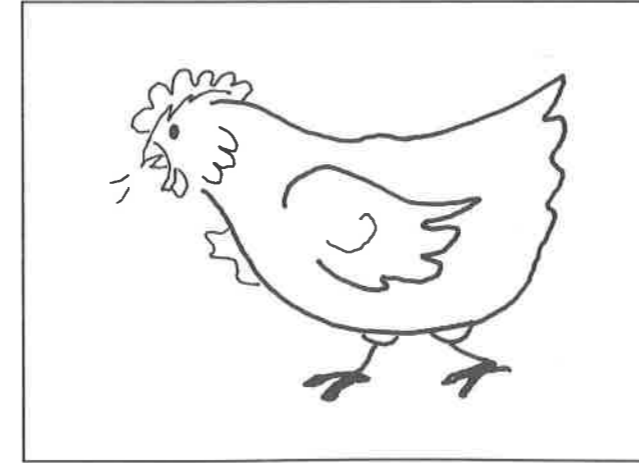
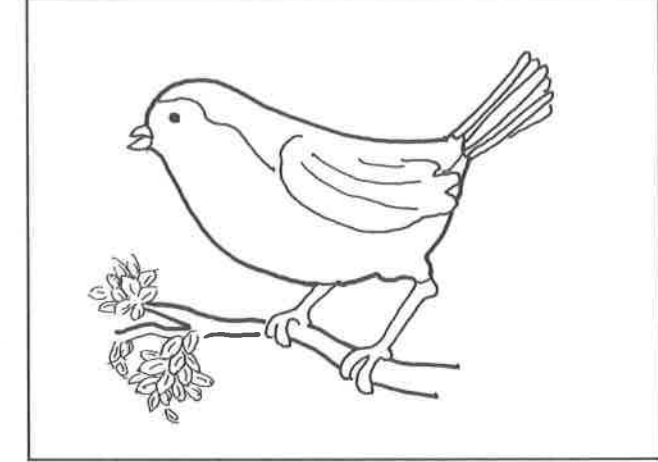
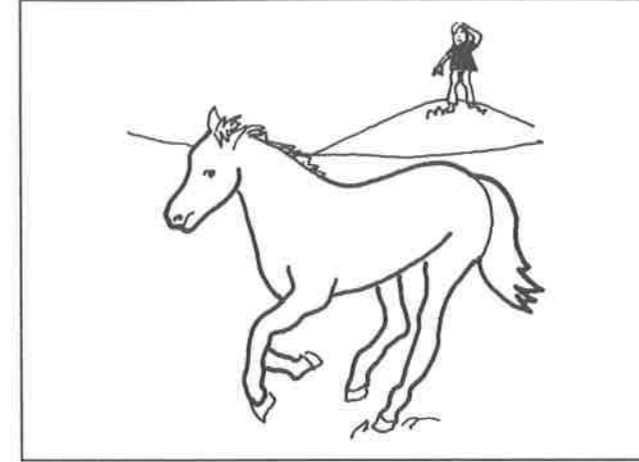
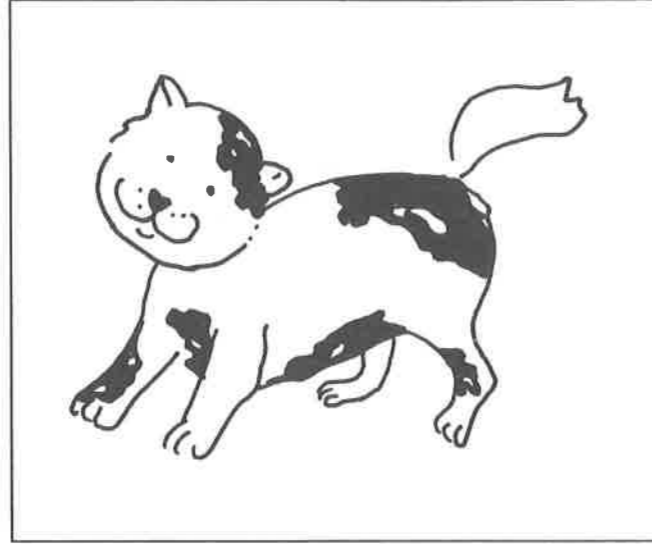
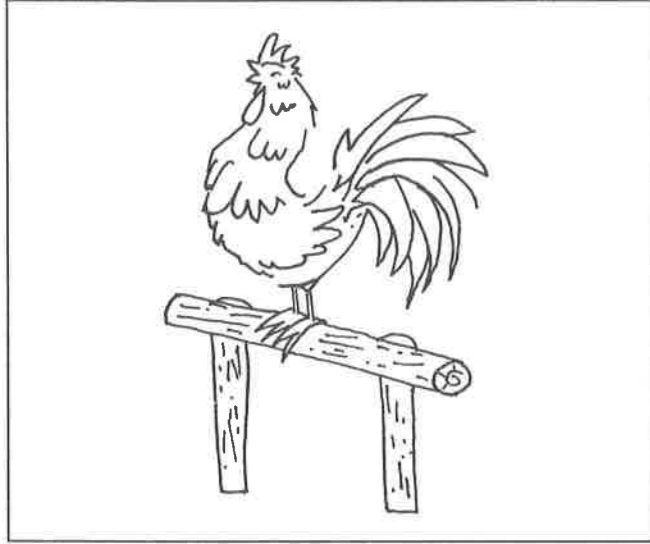
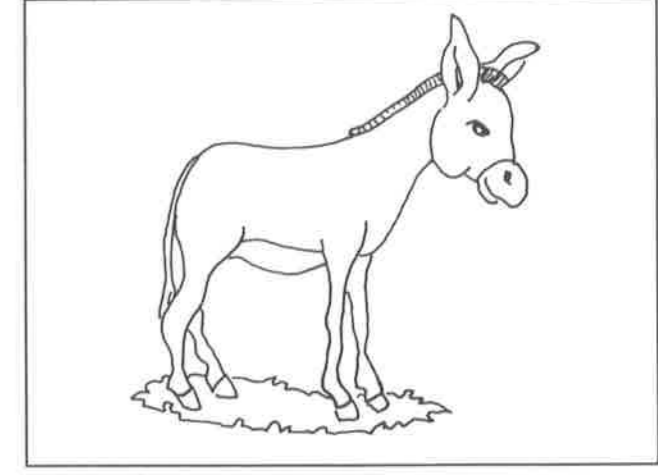
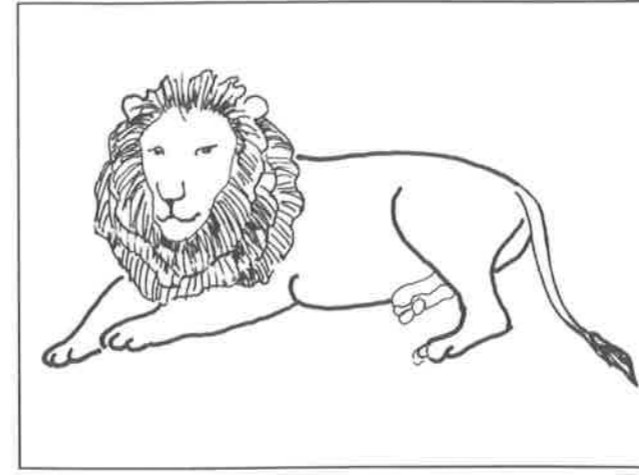
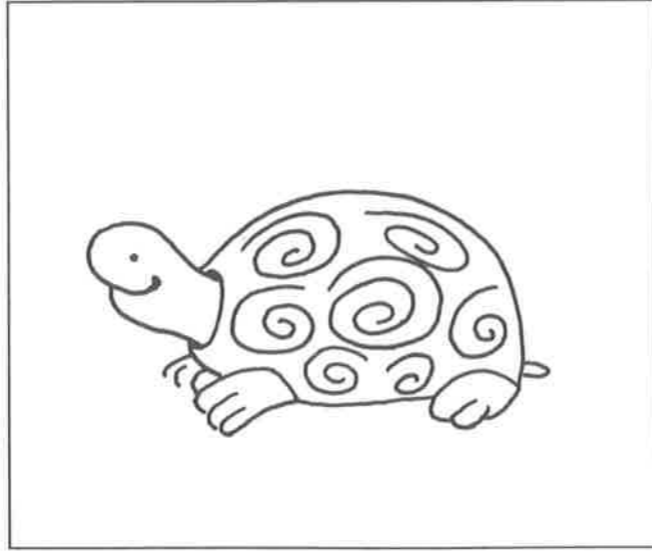
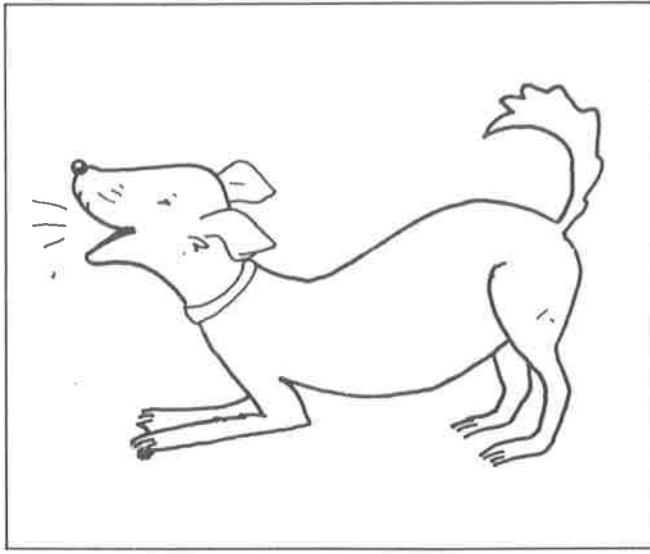

Sesini hiç duymadığımız hayvan hangisi?
İki ayağı olan hayvan hangisi?
Sesini en uzun süre duyabildiğimiz hayvan hangisi?
Havucu en çok seven hangisi? Göster ve boy.

Uçabilen hayvan hangisi? Ağaçta yaşayan hayvanı göster.
En hızlı koşabilen hangisi?
Sırtına binebildiğimiz hayvan hangisi?
Etini ve yumurtasını yediğimiz hayvan hangisi?
Etinden, sütünden ve derisinden yararlandığımız hayvan hangisi?
Yabani olan hangisi?
Anıran hangisi?

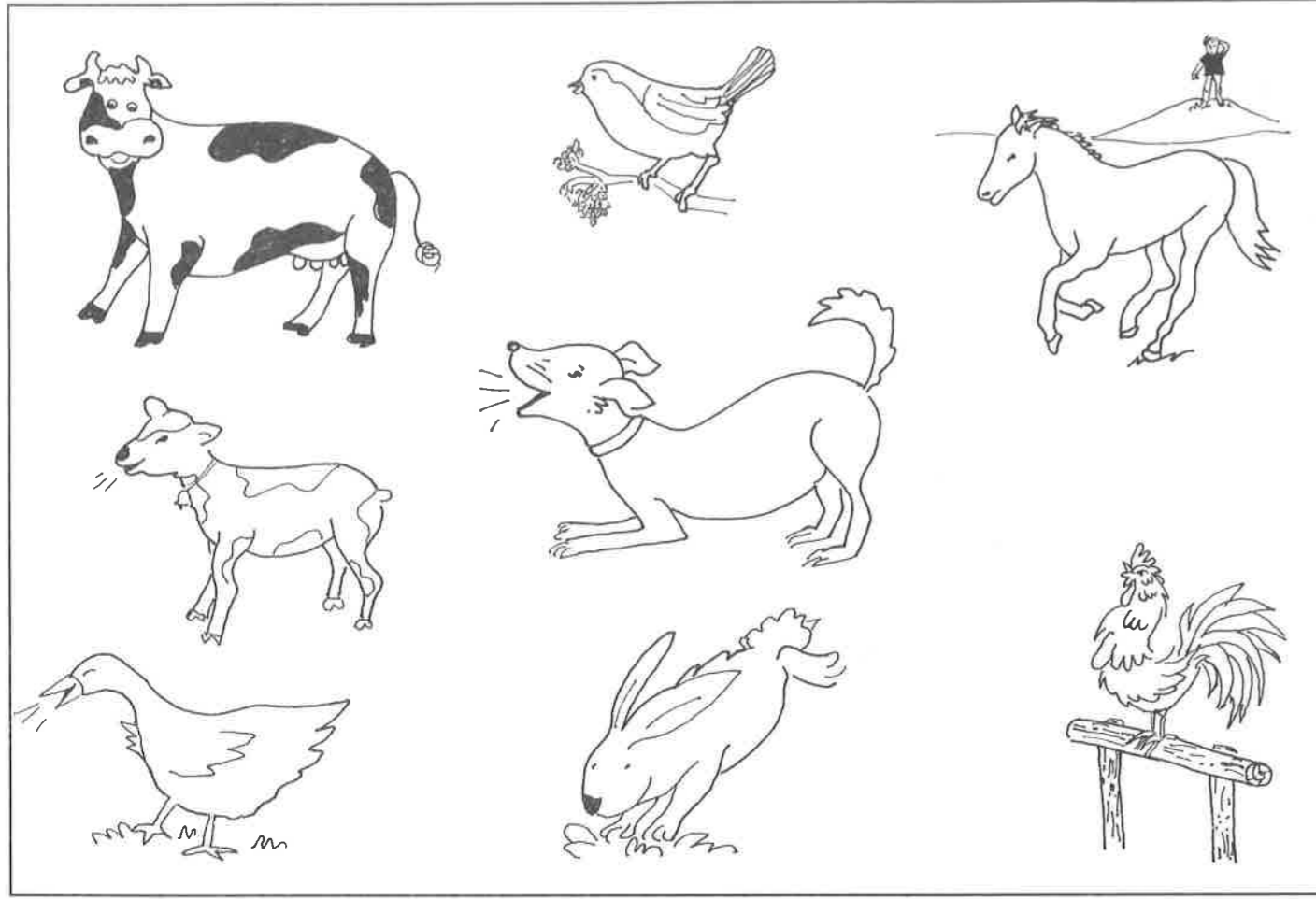

Bu bölümde gördüğün her hayvanın adını söyle. Ne yediklerini, nerede yaşadıklarını anlat.
Bu hayvanlarla ilgili şarkılar söyle. Hayvanları dilediğin gibi boy.

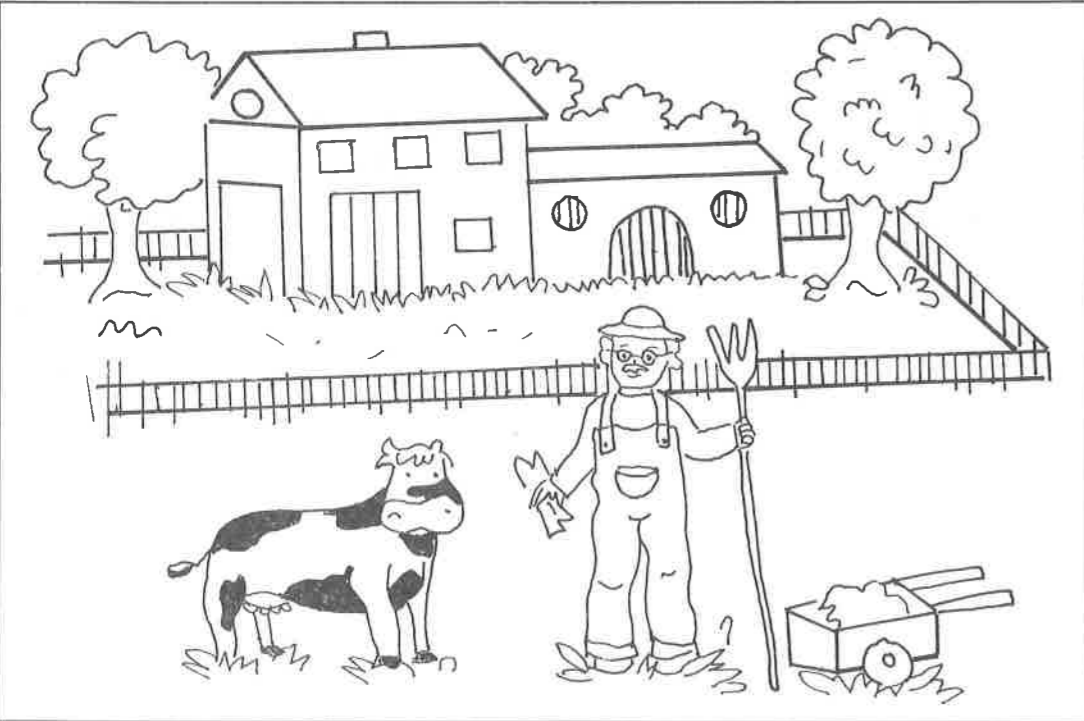

Bu resim ne ile ilgili?
İneğin yanında neler var?
Bu adam ne iş yapıyor?
Anlat ve resmi boy.

Nerede böyle?

is ter sem ö ter mi?

Nerede böyle?

(Çocukluk Çağı Müzik Eğitimi Kitabı S.89'daki "Şimdi Şurda Bir Kuş Var" adlı şarkı söylenir.)
Bu şarkıyı dinle. Şarkının hangi sözü düz gidiyor? Söyle ve düz giden seslerin çizgilerini kırmızı ile çiz. Şarkının hangi sözü inip çıkıyor? Söyle ve inip çıkan seslerin çizgilerini yeşil ile çiz.

Söyleyeceğim şarkıları dinle. (Çocukluk Çağı Müzik Eğitimi S.96'daki **Araba** ile **Ambülans** adlı şarkılar söylenir.) Buradaki ses çizgileri hangi şarkıya uygun? Söyle. Ambülans şarkısının ses çizgilerini aşağıdaki boş kutuya çiz.

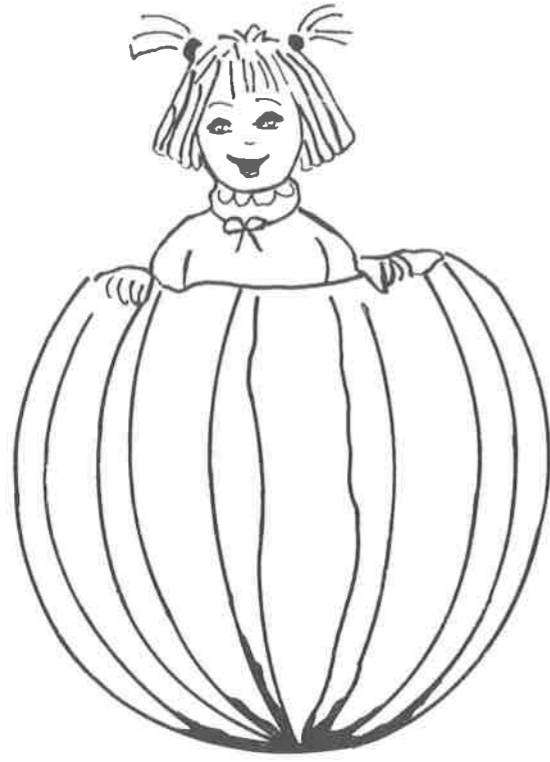

Bu çocuk neyin içine girmiş? Bu resim hangi şarkıyı anımsatıyor?
Şarkıyı söyle ve resmi boya.

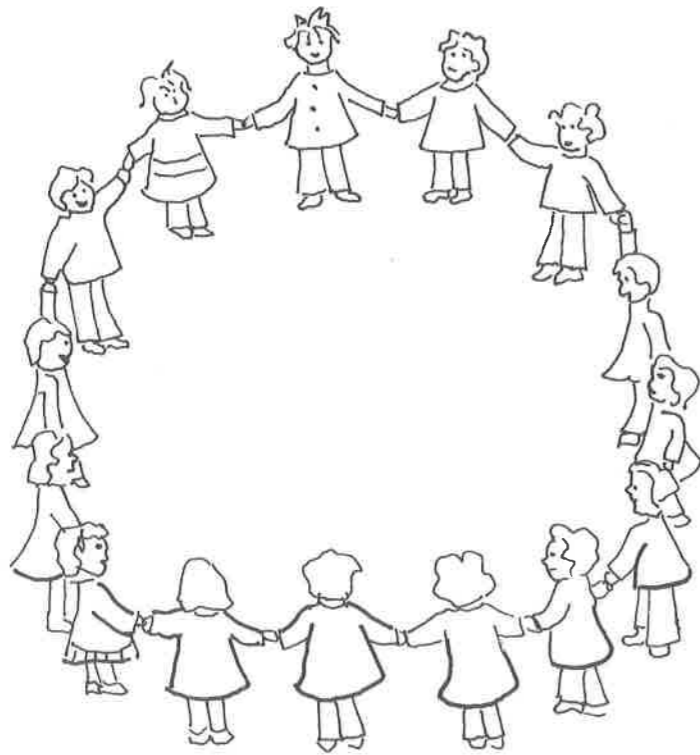

Bu çocuklar ne yapıyorlar? Hangi şarkıyı söylüyorlar?
Böyle el ele tutuşarak söylenen başka şarkı var mı? Söyle ve resmi boya.

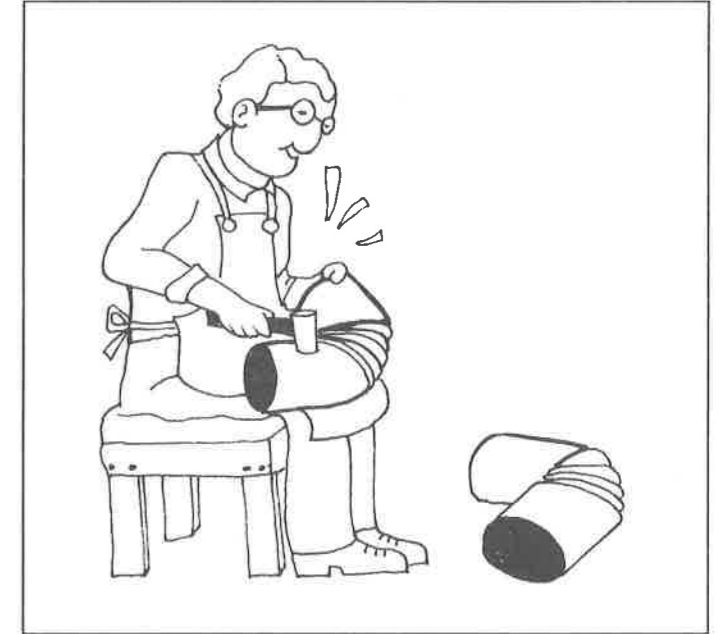
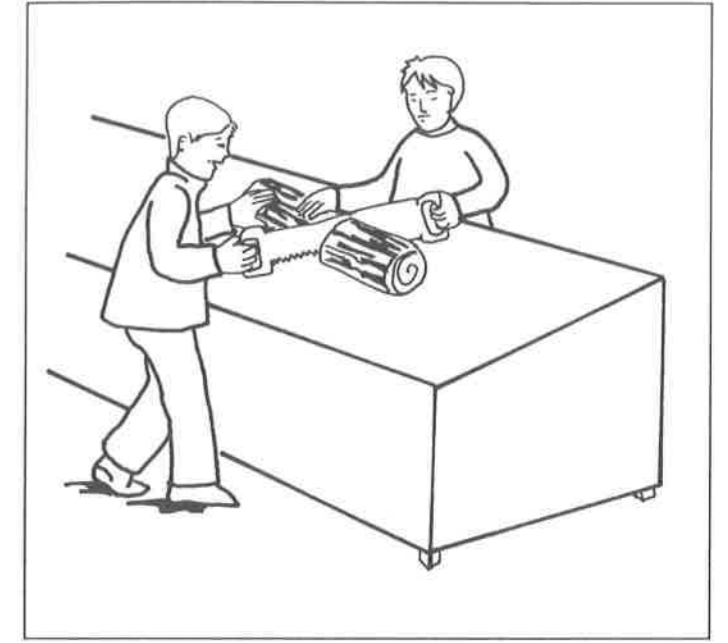

(Yetişkin bir resmi gösterir) Bu resme bakarak hangi şarkıyı söylemek istersin?

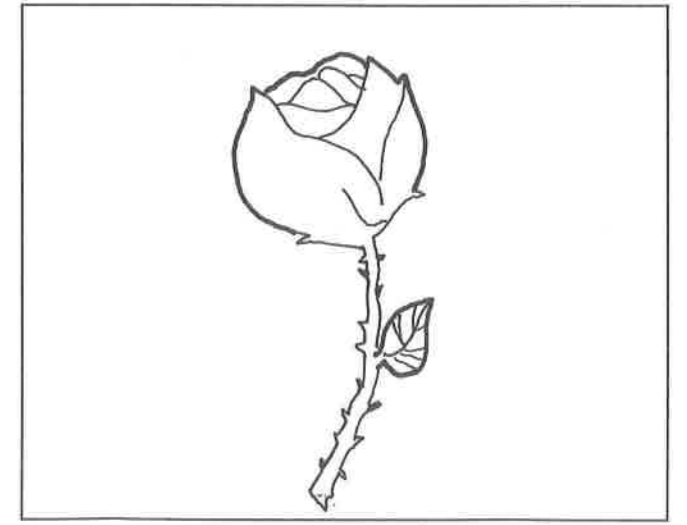
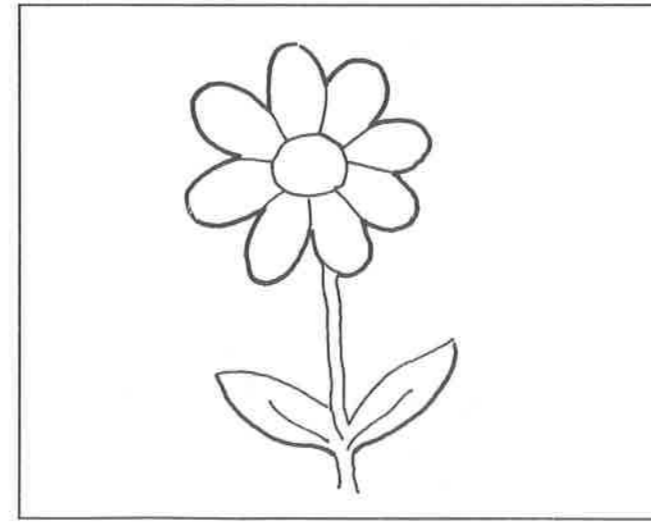
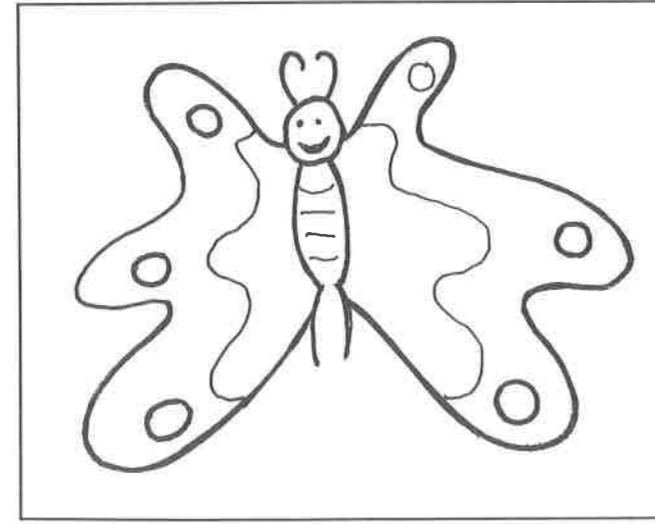
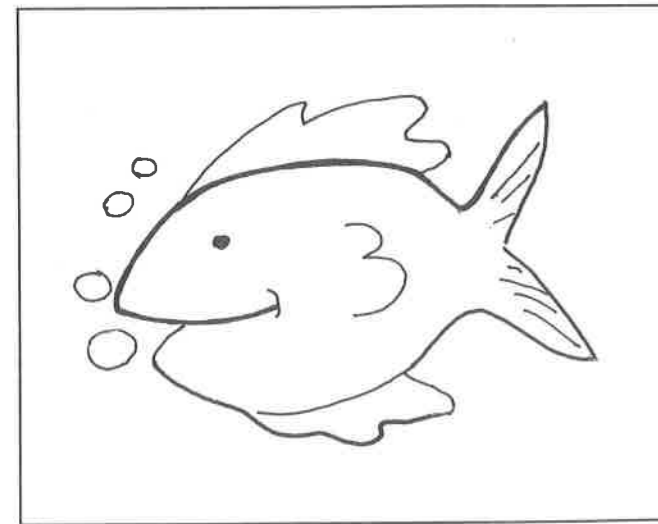
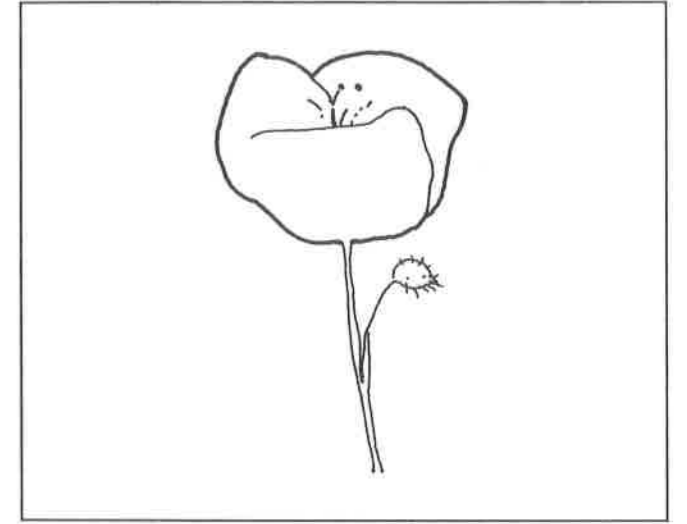
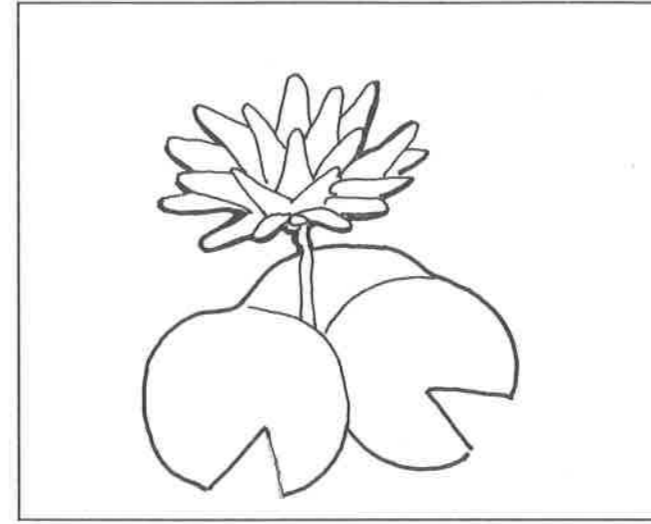
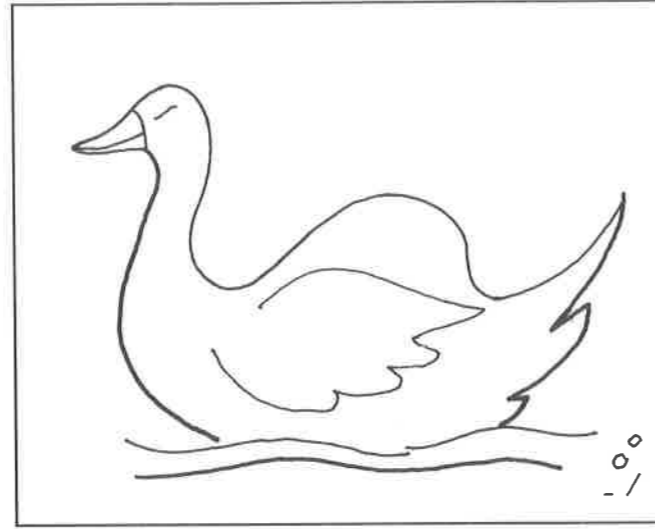
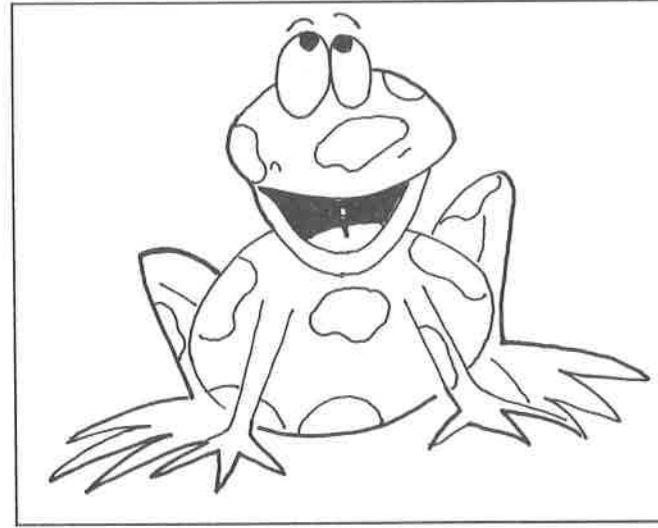
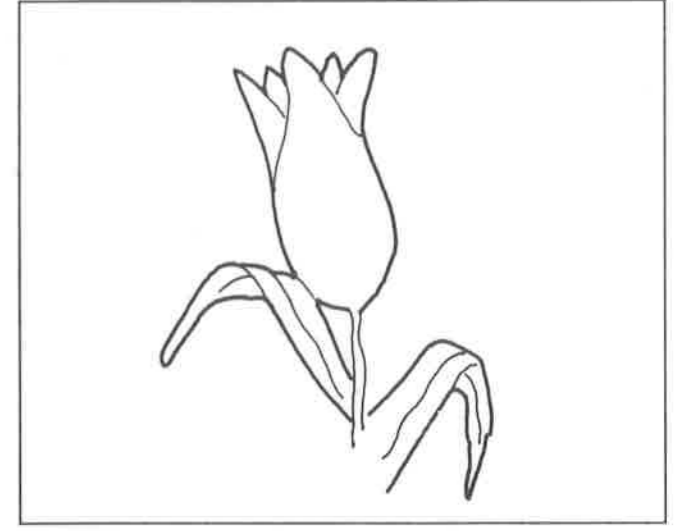
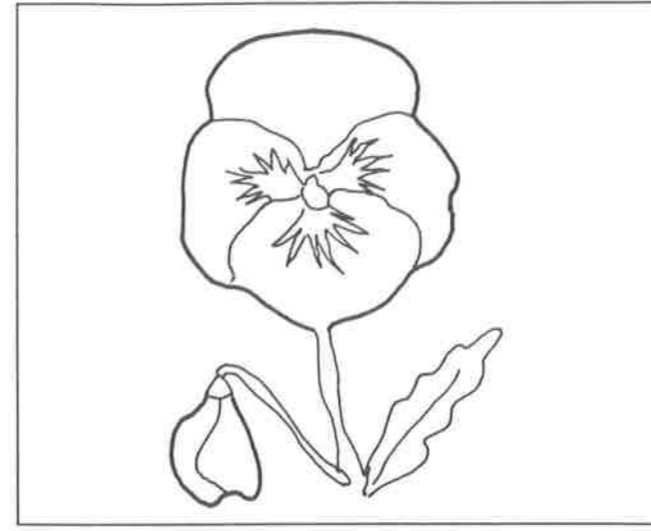
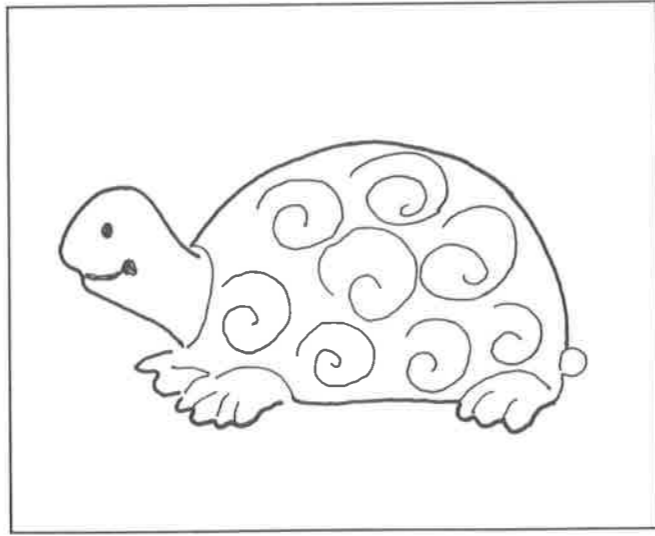
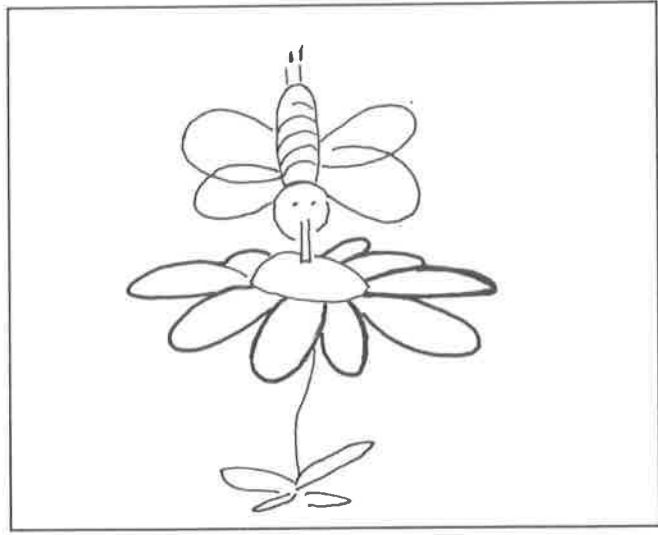

(Efekt ses bandından Kurbağa sesi dinletilir.) Sesini dinlediğin hayvanı göster.
Hem suda hem karada yaşayan başka hayvan var mı? Göster ve boy.

- 1) Dikeni olan çiçeği göster ve boy.
- 2) Suda yetişen çiçeği göster ve boy.
- 3) Kökü soğan olan çiçek hangisi? Göster ve boy.
- 4) Kırdaki yetişen çiçeği göster ve boy.

MÜZİK TESTİ: 1

Bu yay hangi müzik aletine aittir?

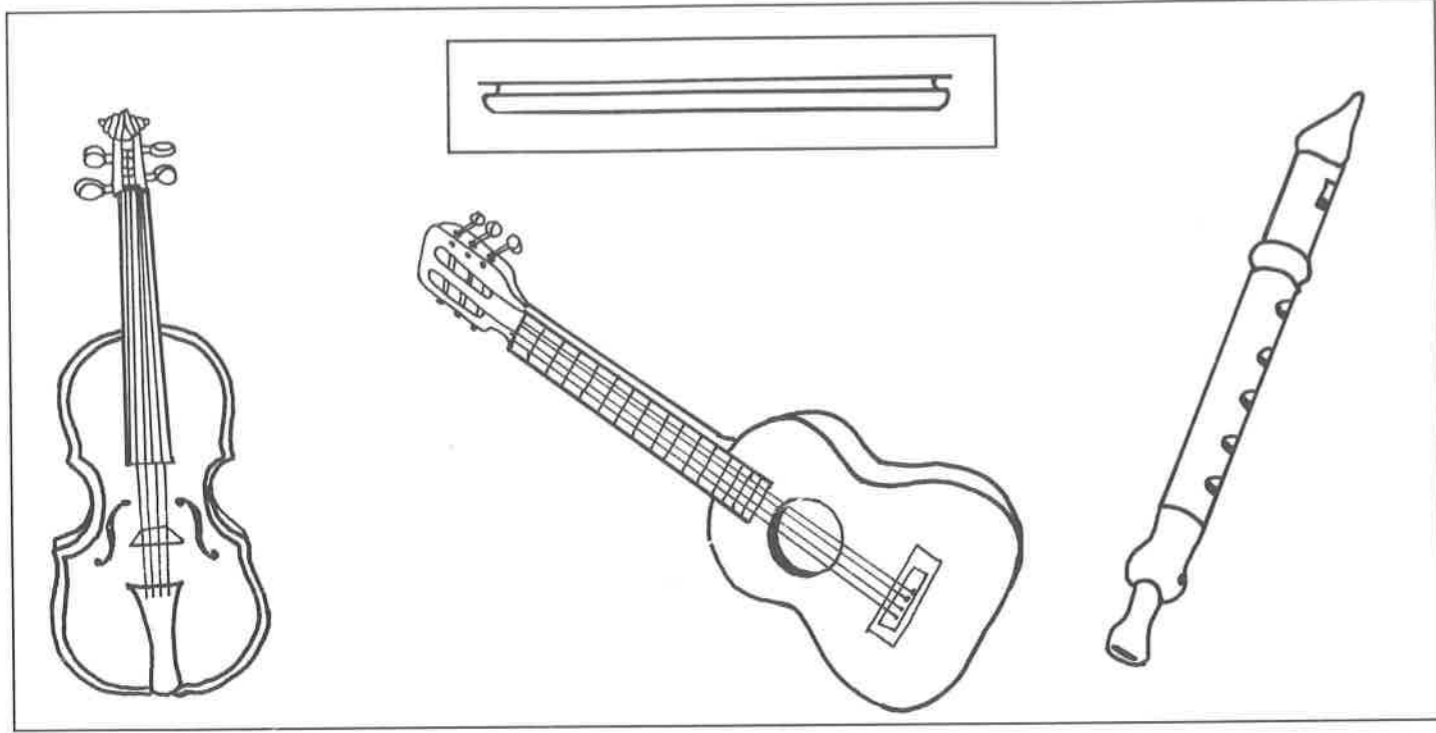

MÜZİK TESTİ: 2

Bu çocuk hangi aleti çalıyor?

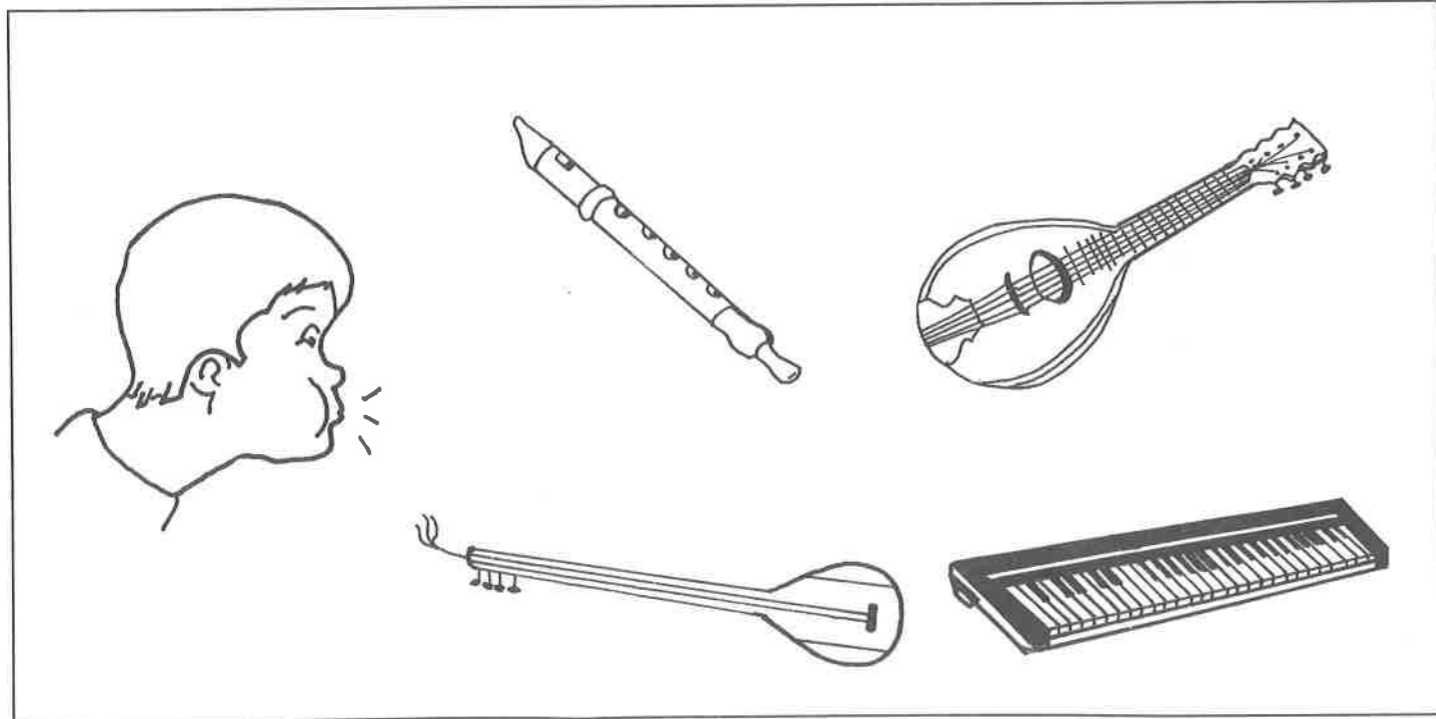

MÜZİK TESTİ: 3

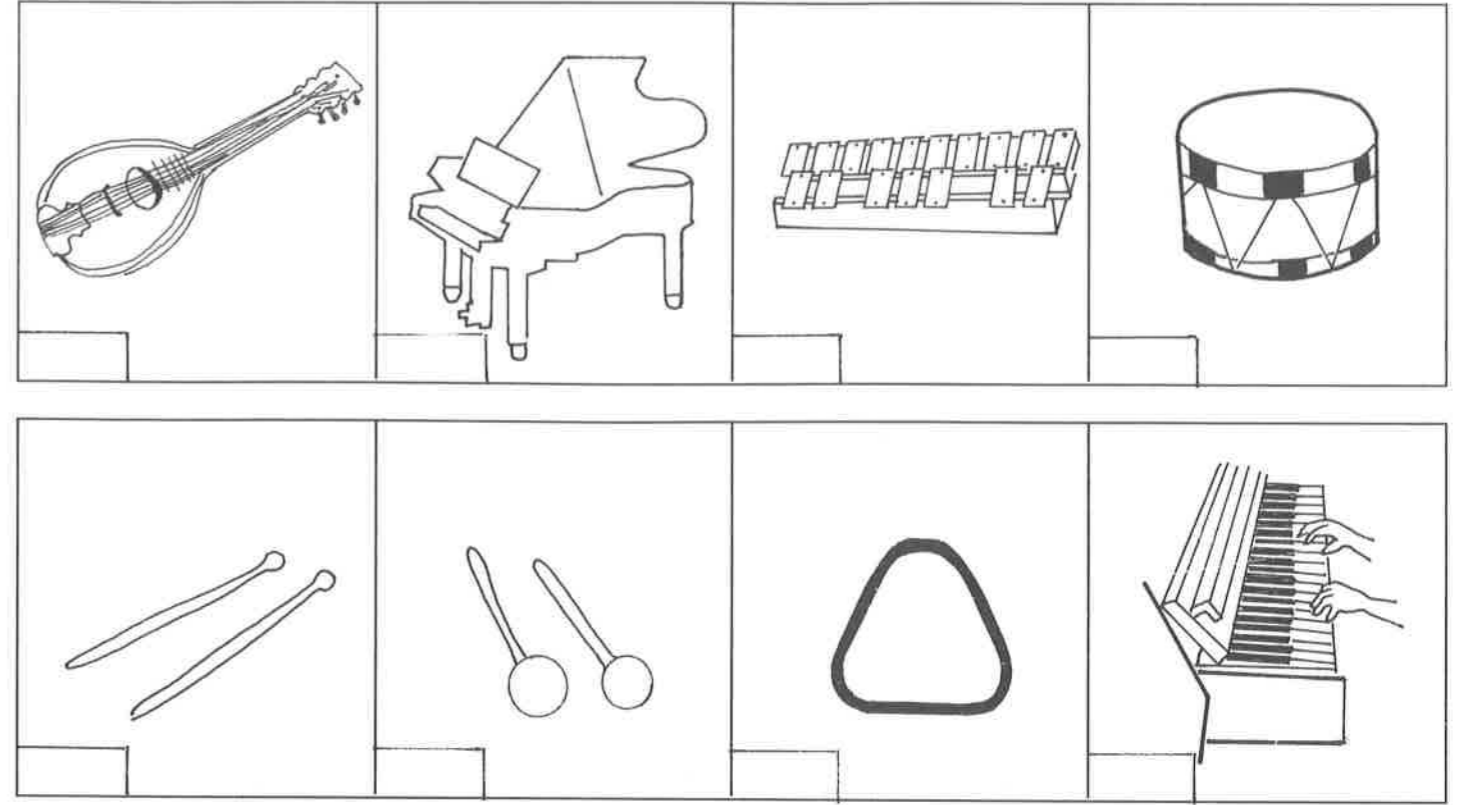

Üst sıradaki her çalgıya uygun parçayı, alt sırada bul.
Her çalgının ve parçasının altındaki boş kutuyu aynı renge boy.

MÜZİK TESTİ: 4

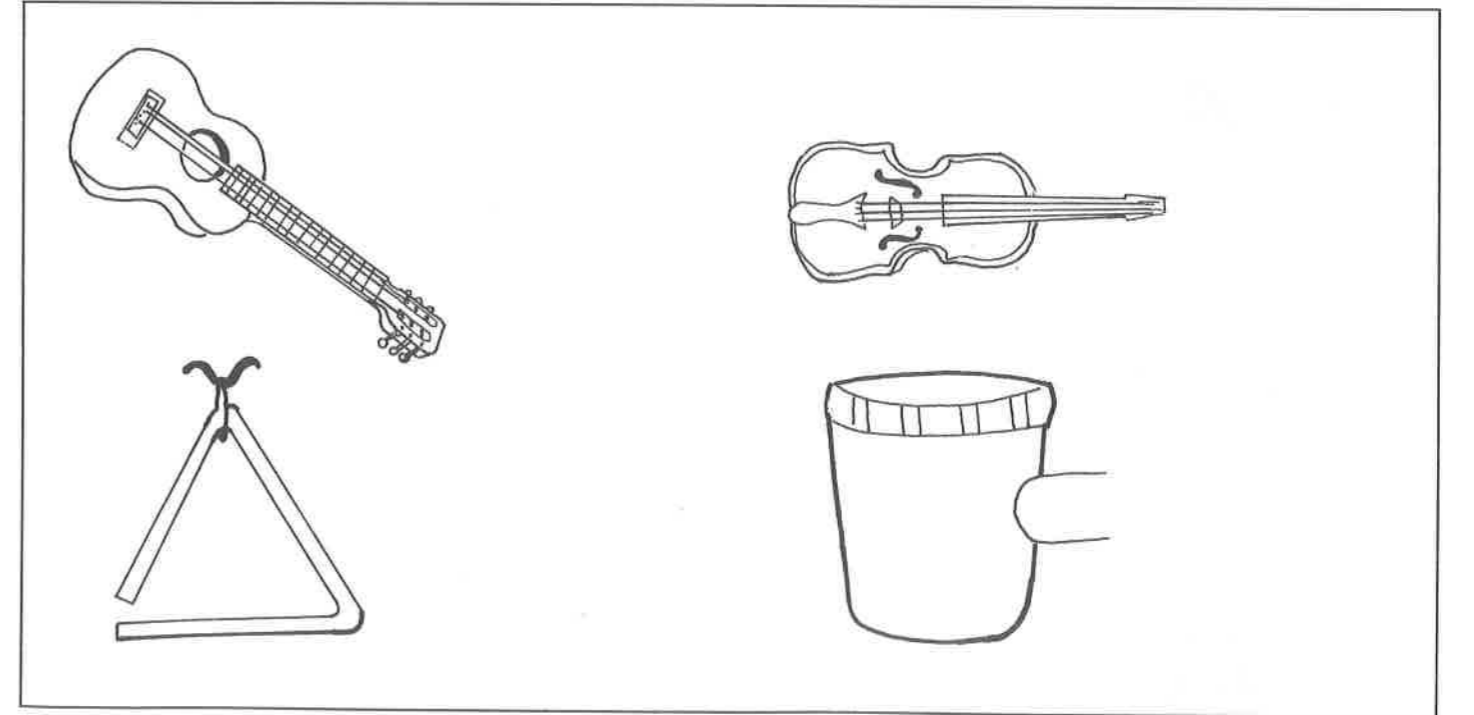

Buradaki her müzik aletinin eksliğini söyle.
Eksliğini çiz ve boy.

MÜZİK TESTİ: 5

Aşağıdaki sesleri hangi aletten verebilirsiniz? Eşleştiriniz.

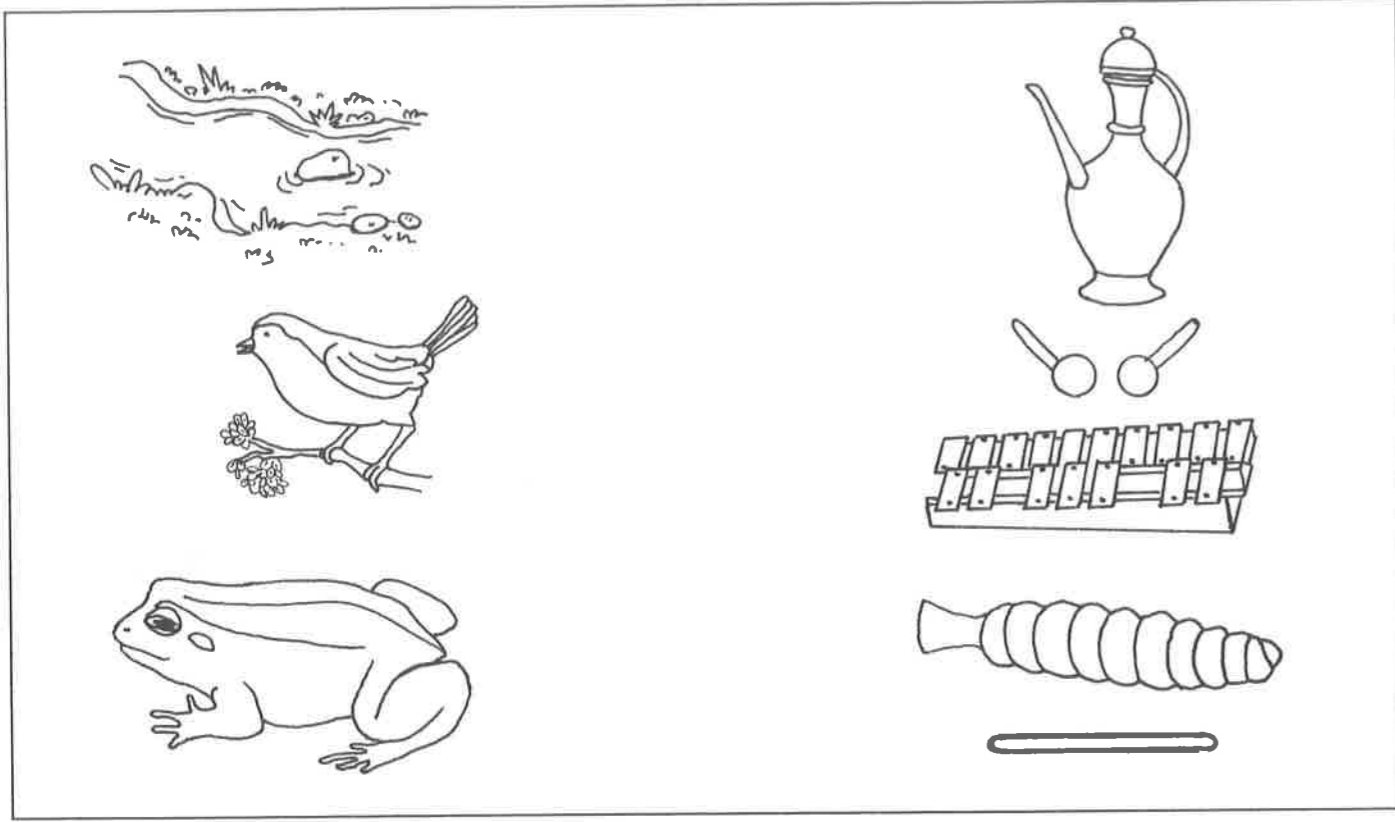

MÜZİK TESTİ: 6

Askerin uygun adım yürüdüğü sesi hangisi verir?

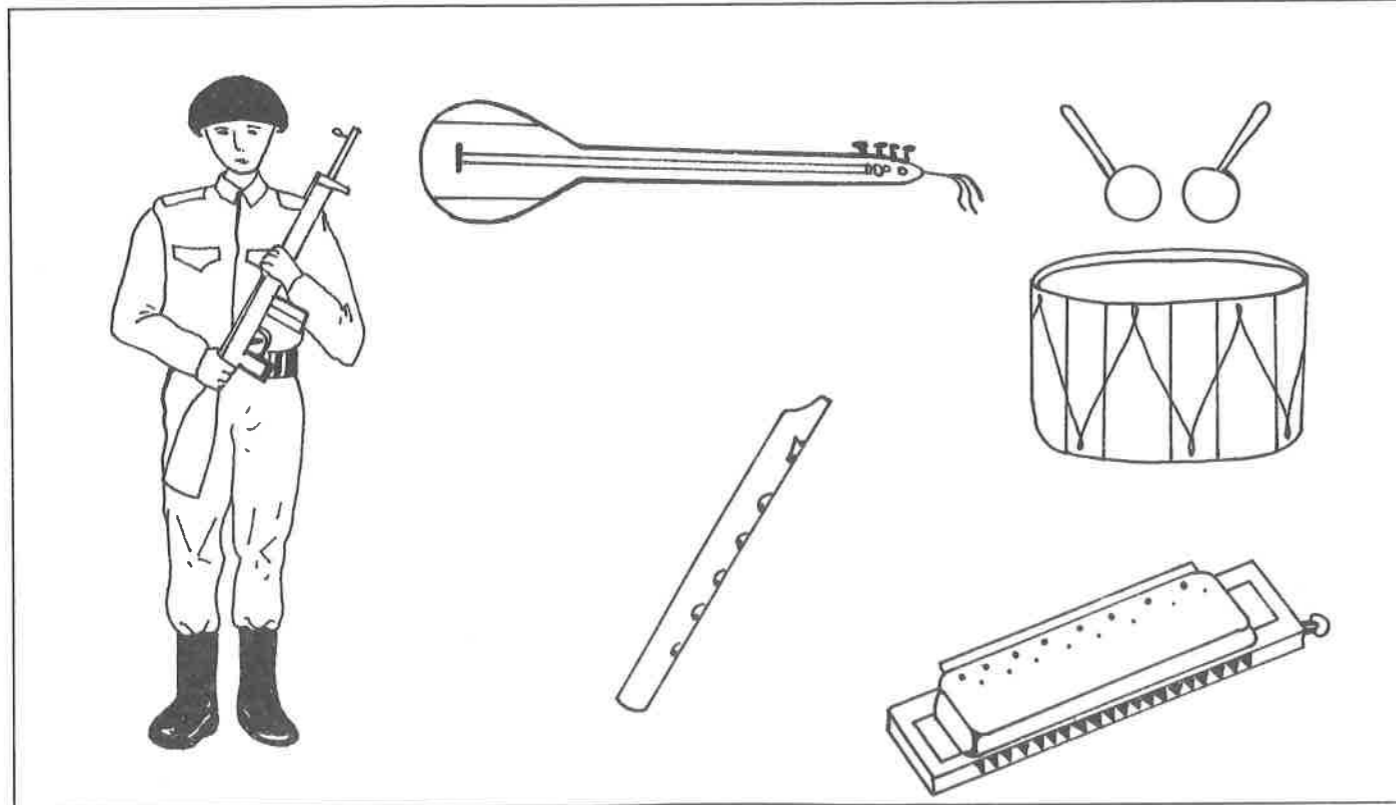

MÜZİK TESTİ: 7

Hangisi en hızlı gider? Seslerini çıkararak anlayabilir miyiz?

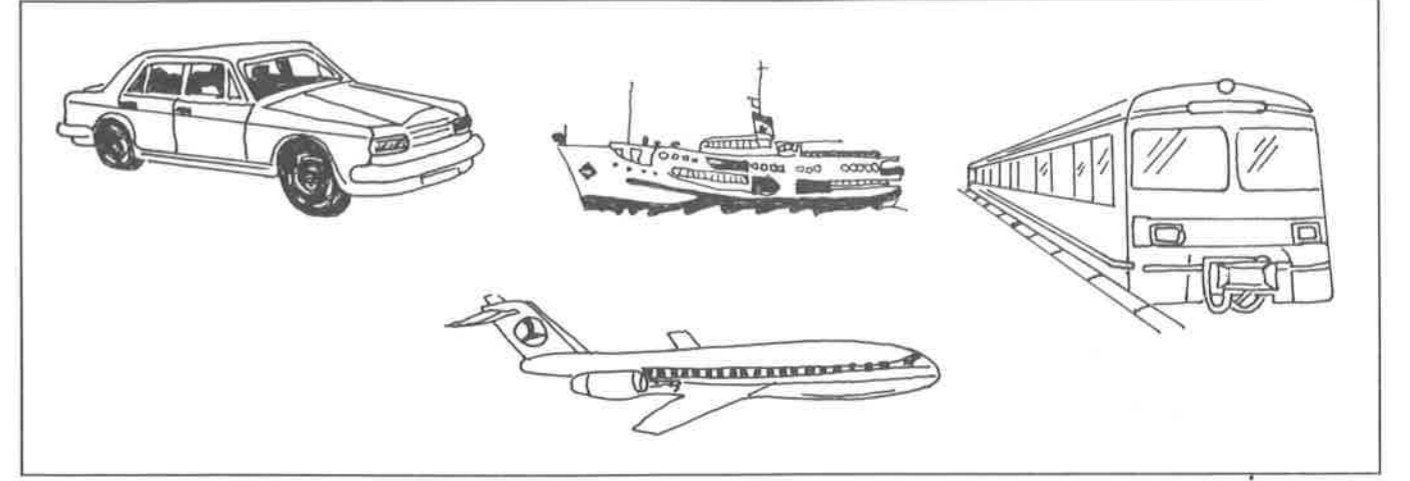

MÜZİK TESTİ: 8

Hangisi en yavaş gider? Yürümelerini taklit ederek anlayabilir miyiz?

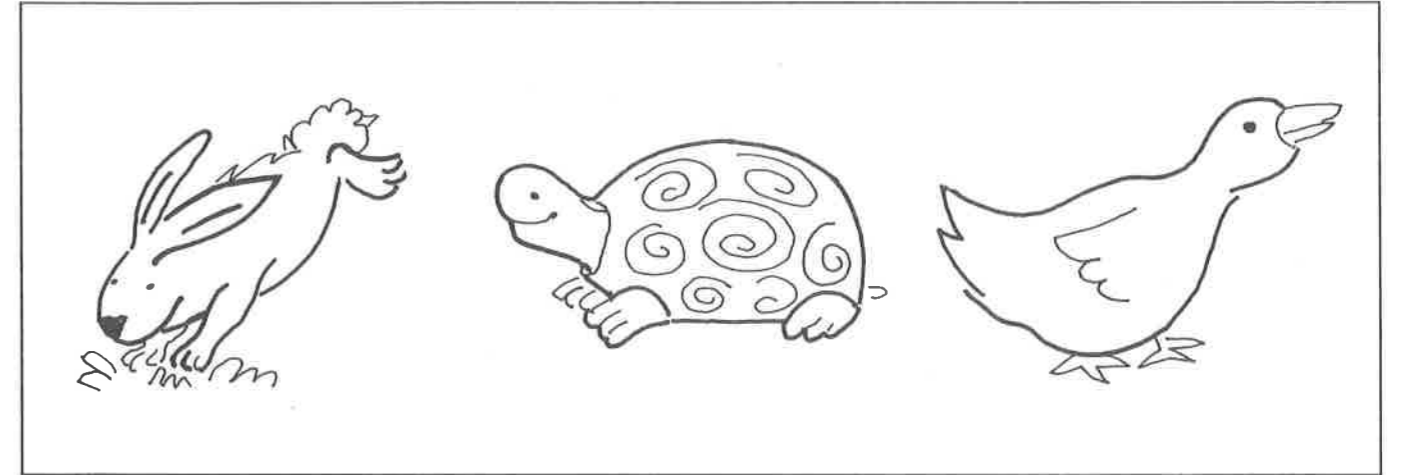

MÜZİK TESTİ: 9

Hangisi en uzun öter? Seslerini taklit ederek bulalım.

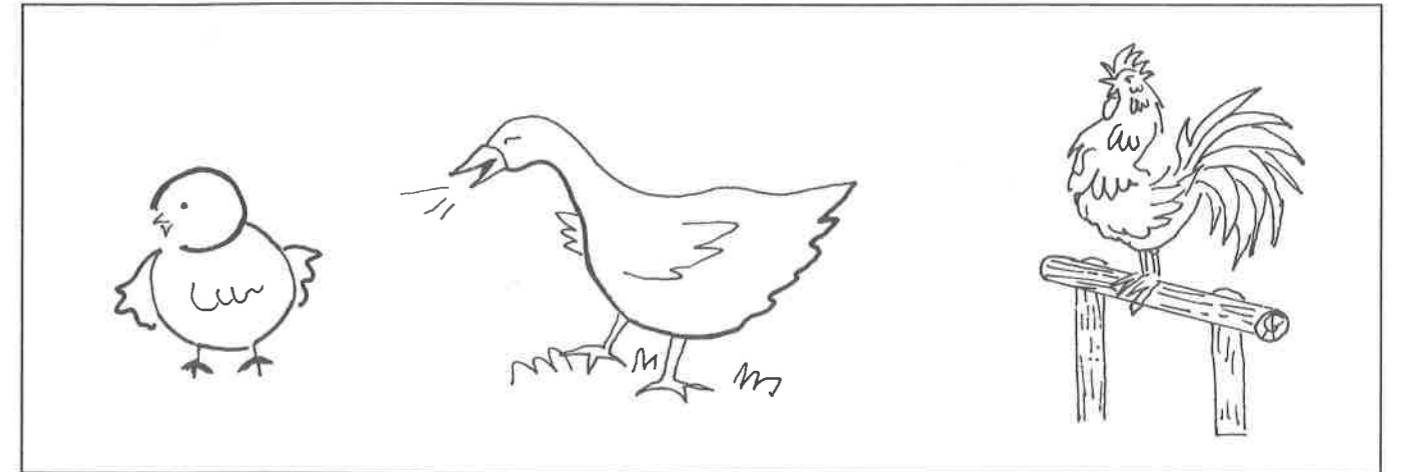

MÜZİK TESTİ: 10

Hangisi en hafif sesi verir?

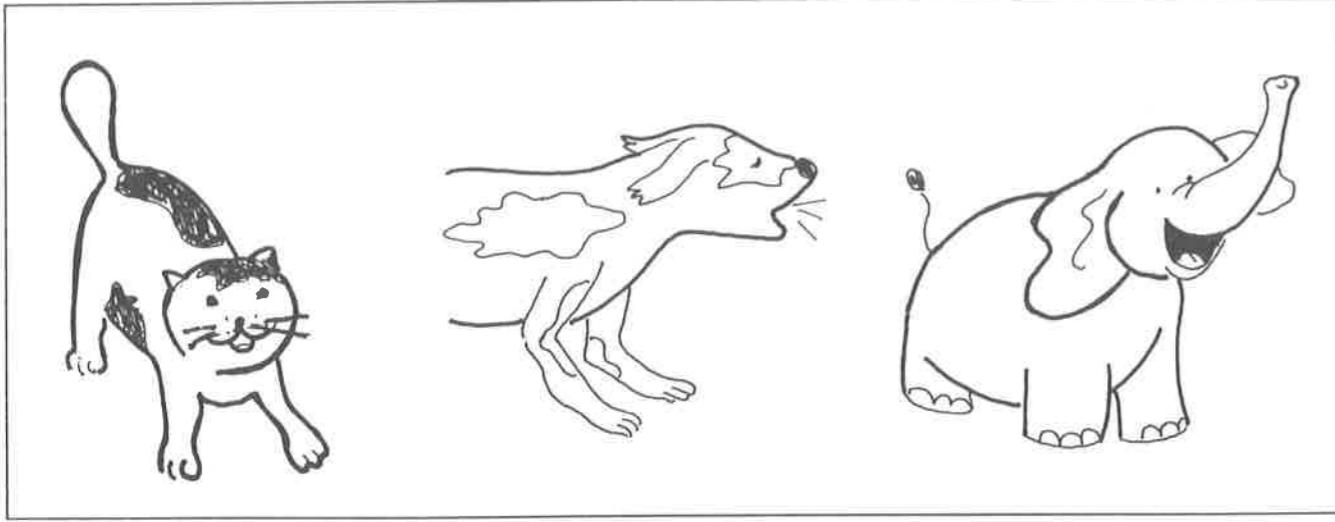

MÜZİK TESTİ: 11

Hangisi en kuvvetli sesi verir?

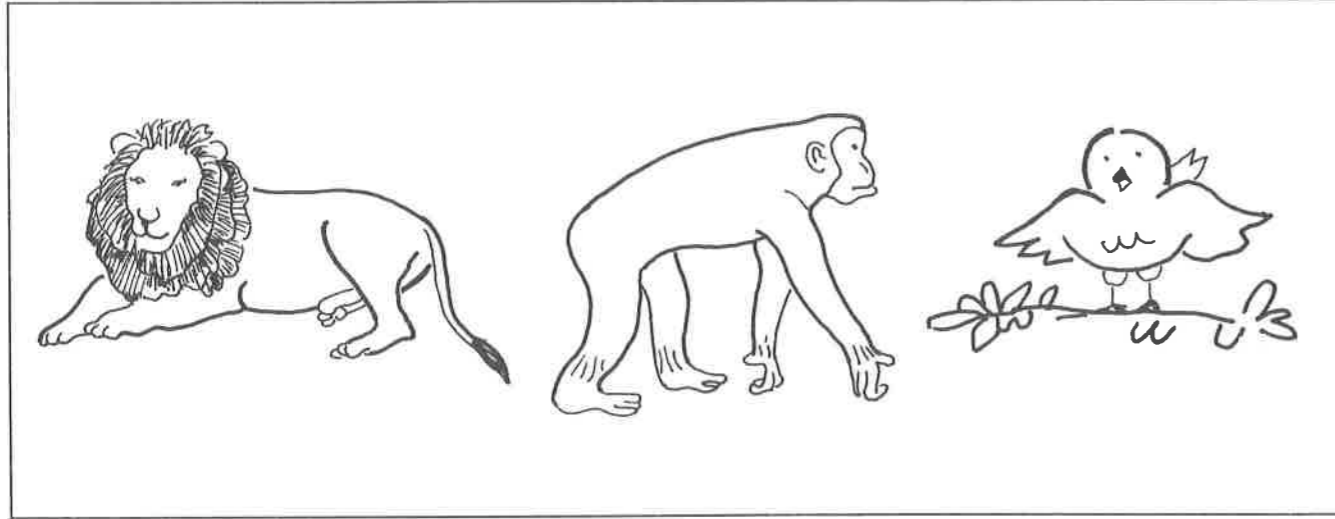

MÜZİK TESTİ: 12

Hangisi en kısa sesi verir?

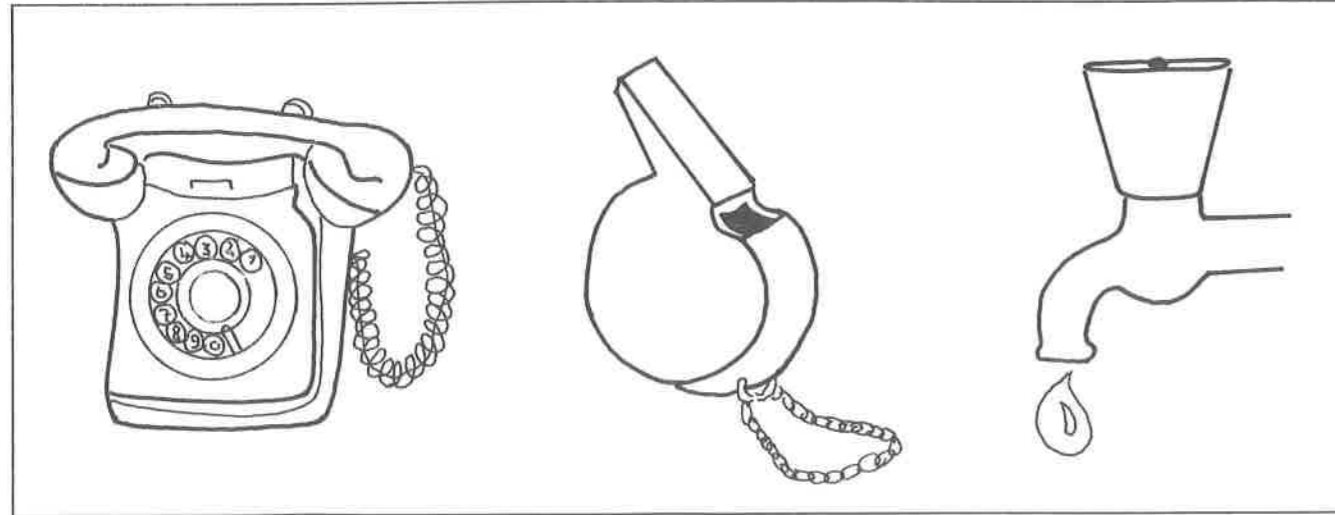

MÜZİK TESTİ: 13

Bu keman tellerinden hangisi en ince sesi verir?

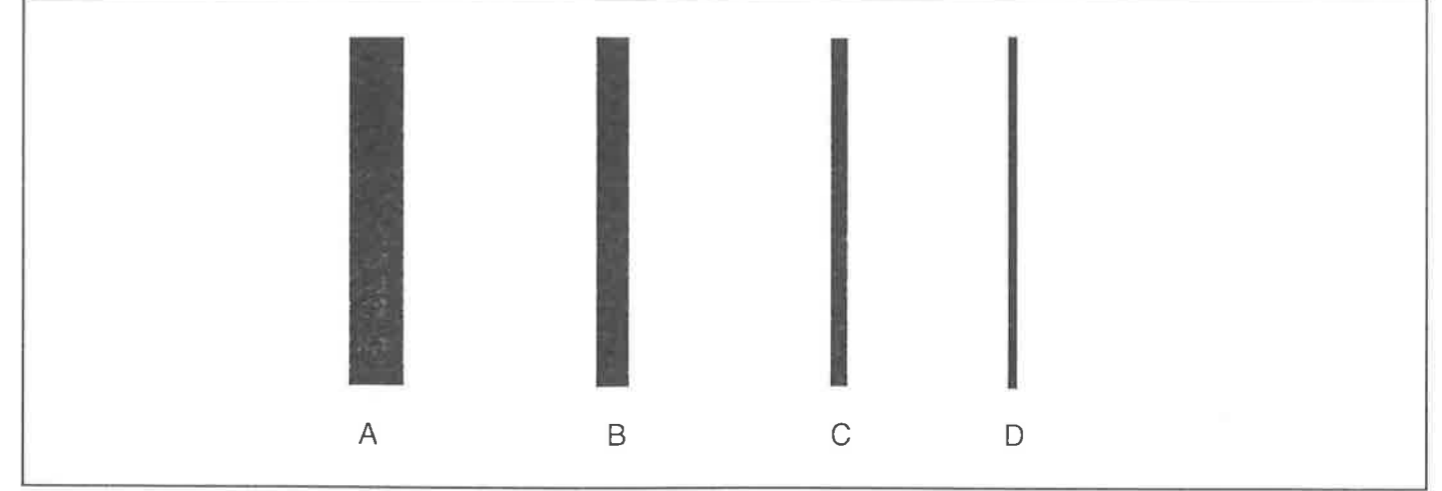

MÜZİK TESTİ: 14

Bu ses kutularından hangisi en kalın sesi verir?

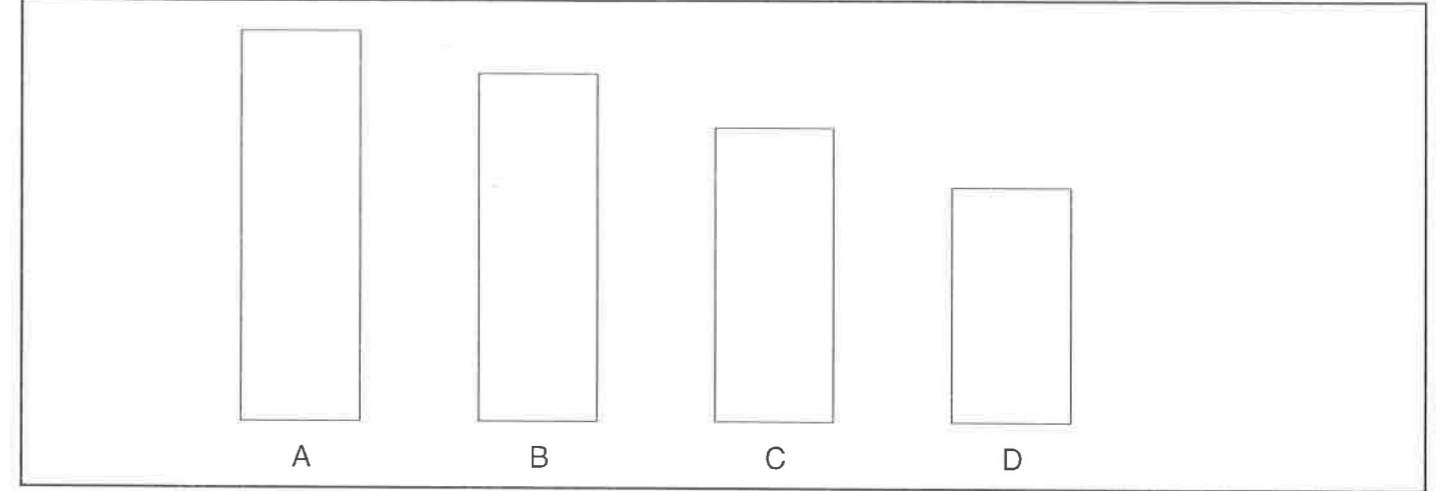

MÜZİK TESTİ: 15

Bu davullardan hangisi en kuvvetli çalar?

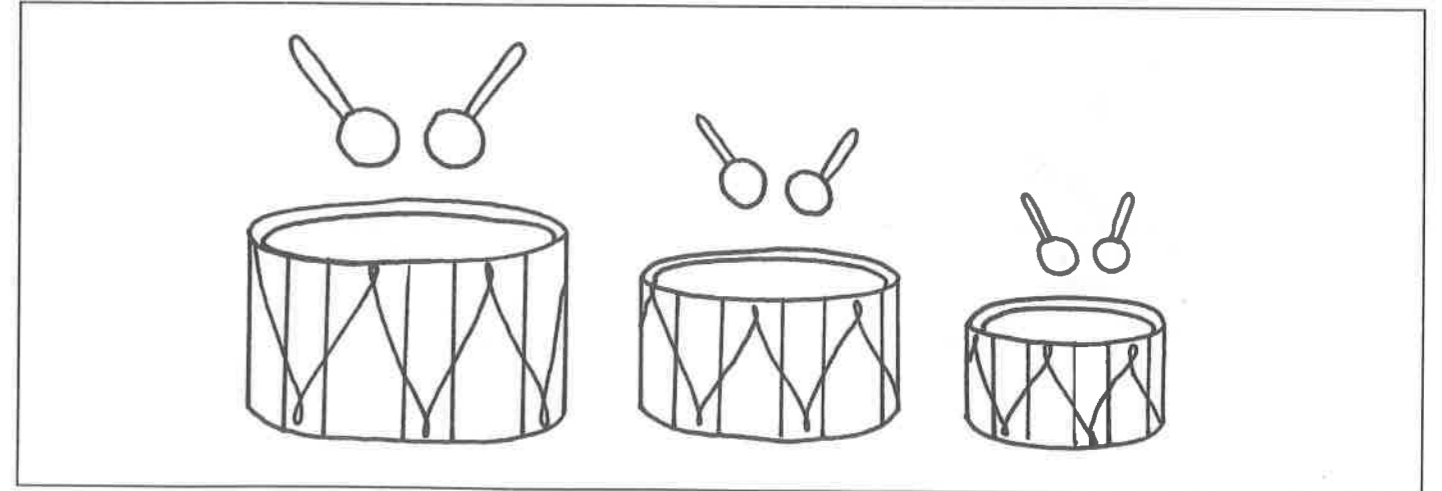

MÜZİK TESTİ: 16

(Efekt sesi kullanarak veya bongodan ritim vererek) Dinlediğiniz nal sesleri hangi atın sesidir?

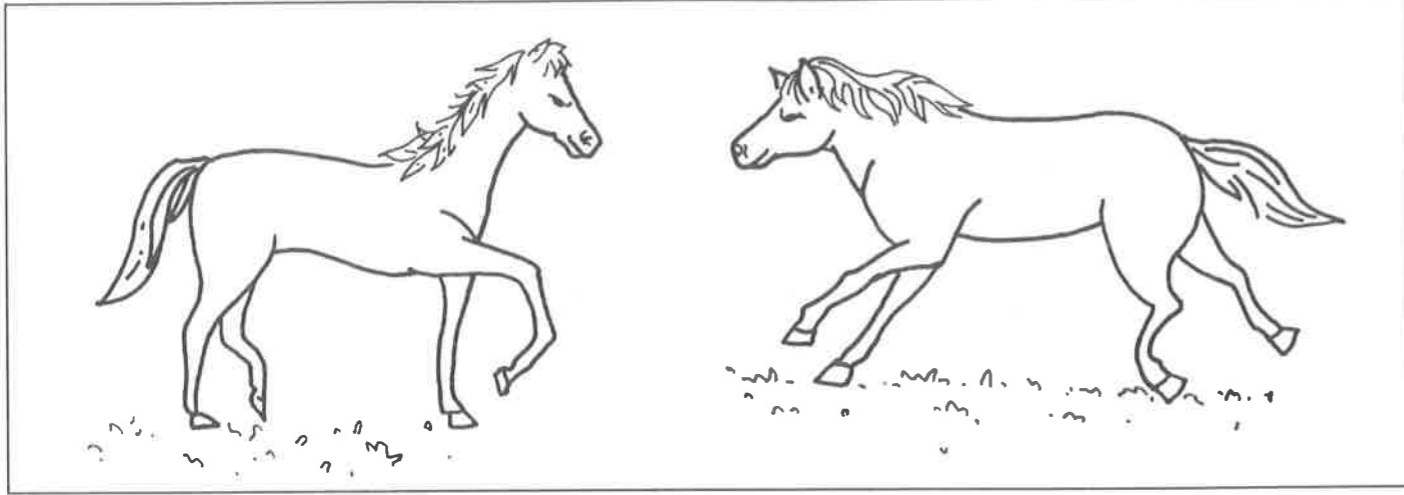

MÜZİK TESTİ: 17

Hangi tren daha hızlı gidiyor? (Efekt hızlı giden tren sesi verilir.)

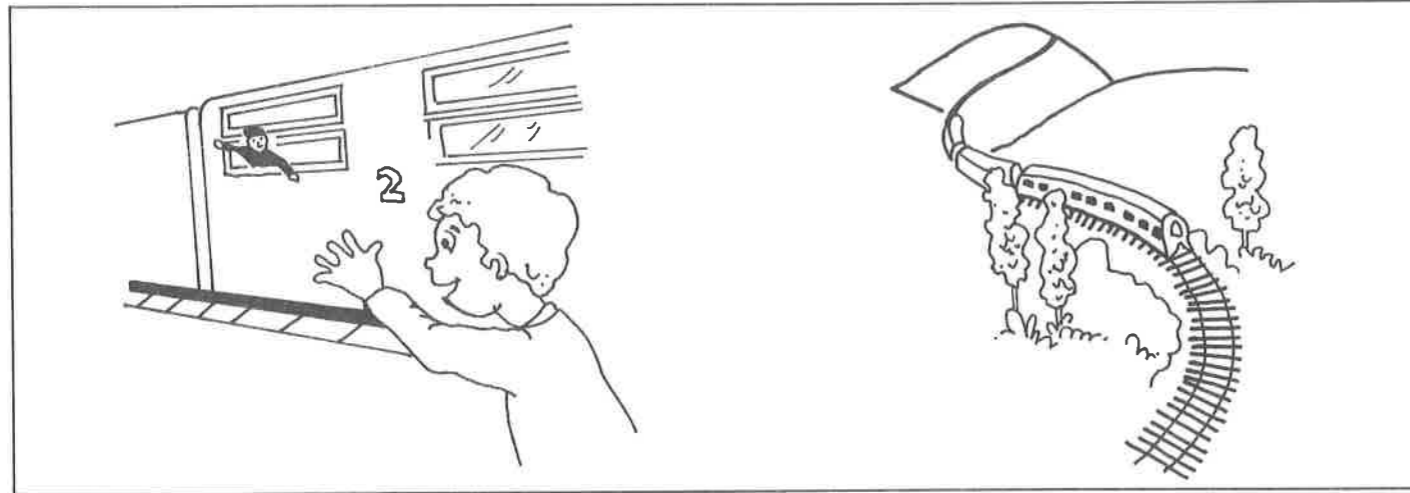

MÜZİK TESTİ: 18

Hangisi daha kuvvetli ses verir?

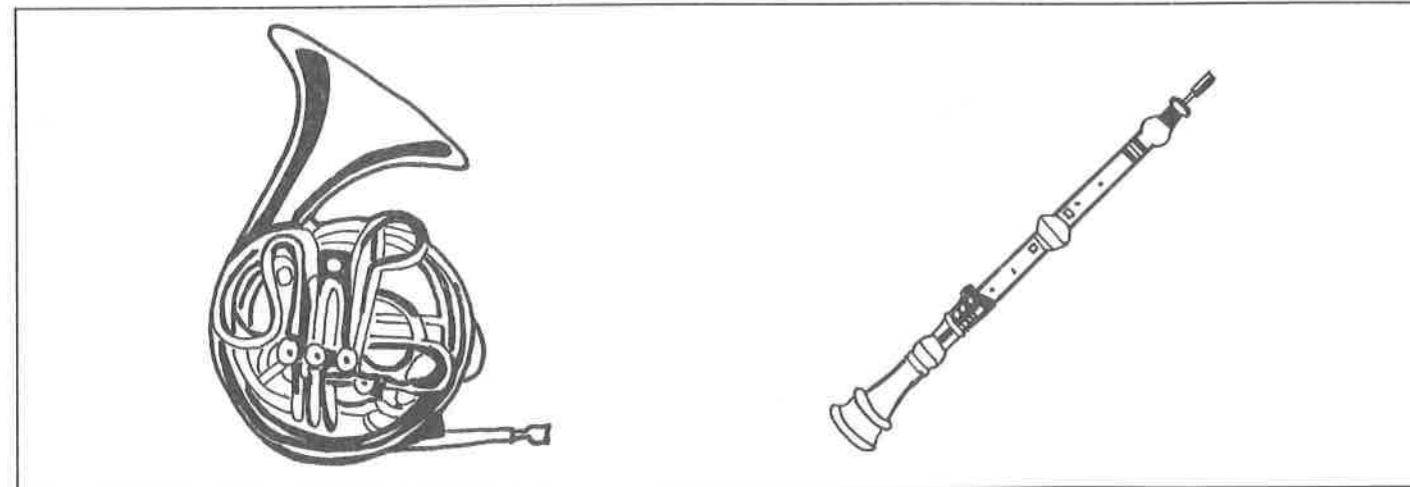

MÜZİK TESTİ: 19

Koşan atın nal seslerini en kuvvetli ne zaman duyarız?
At bize yaklaştığı zaman mı, uzaklaştığı zaman mı?
İlgili resmi boya.

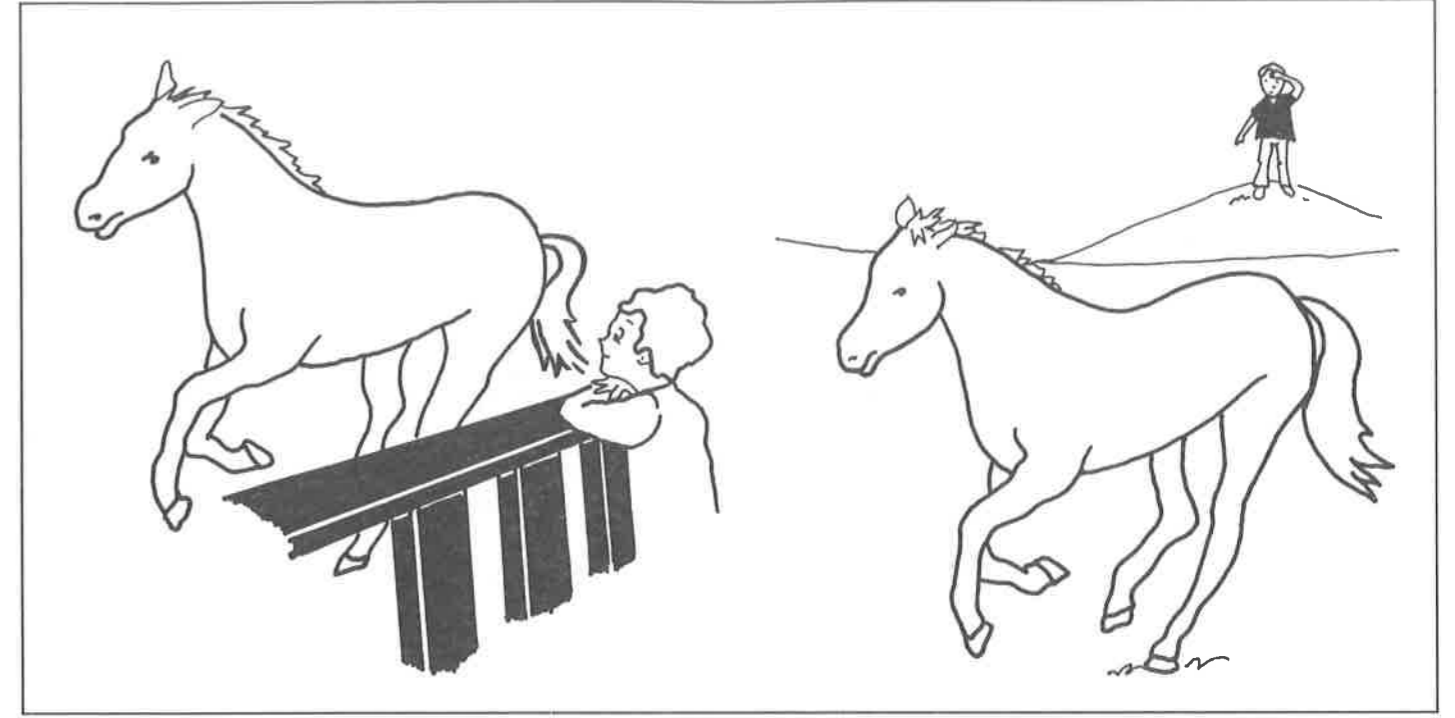

MÜZİK TESTİ: 20

(Efekt Ses Kaydı ile) Hangi kamyonun sesi gittikçe hafif duyulur? Bizden uzaklaşan mı, bize yaklaşan mı? İlgili resmi boya.

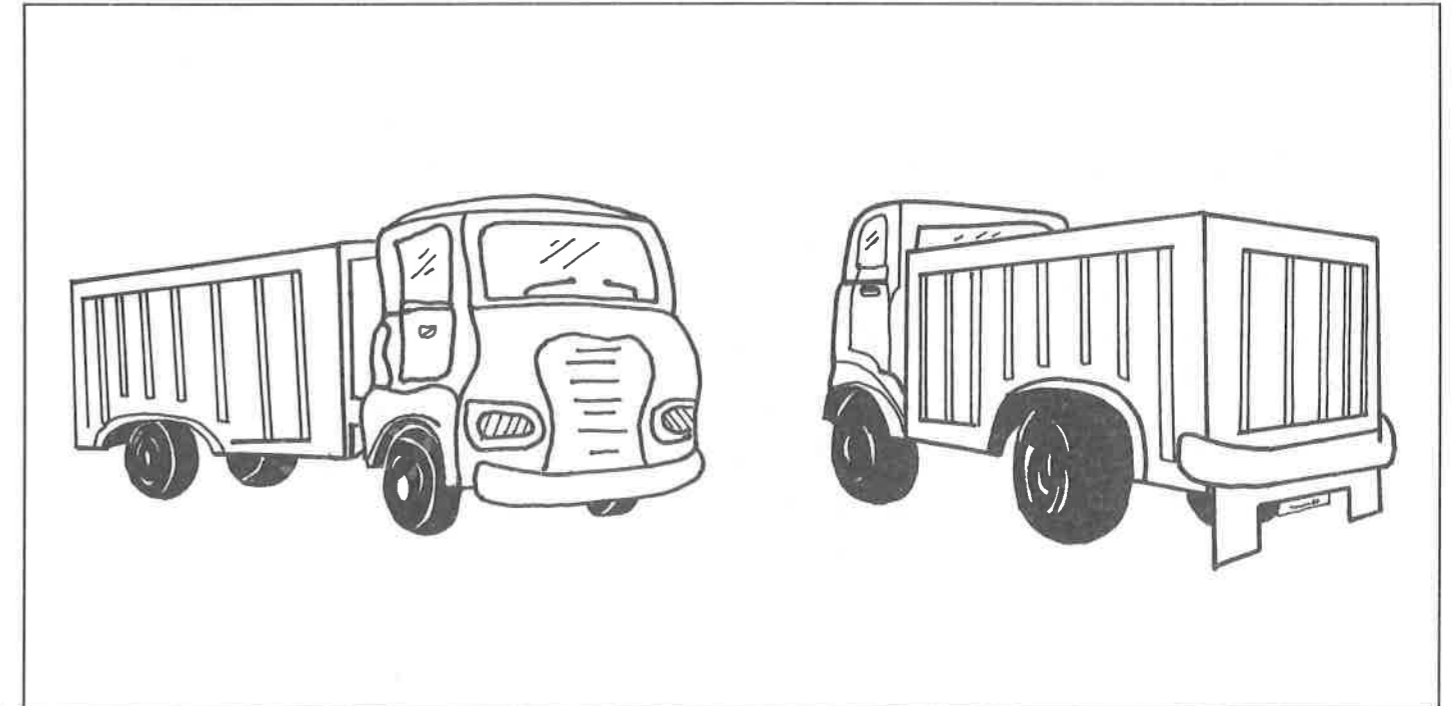

MÜZİK TESTİ: 21

Bu çocuk ne dinliyor?

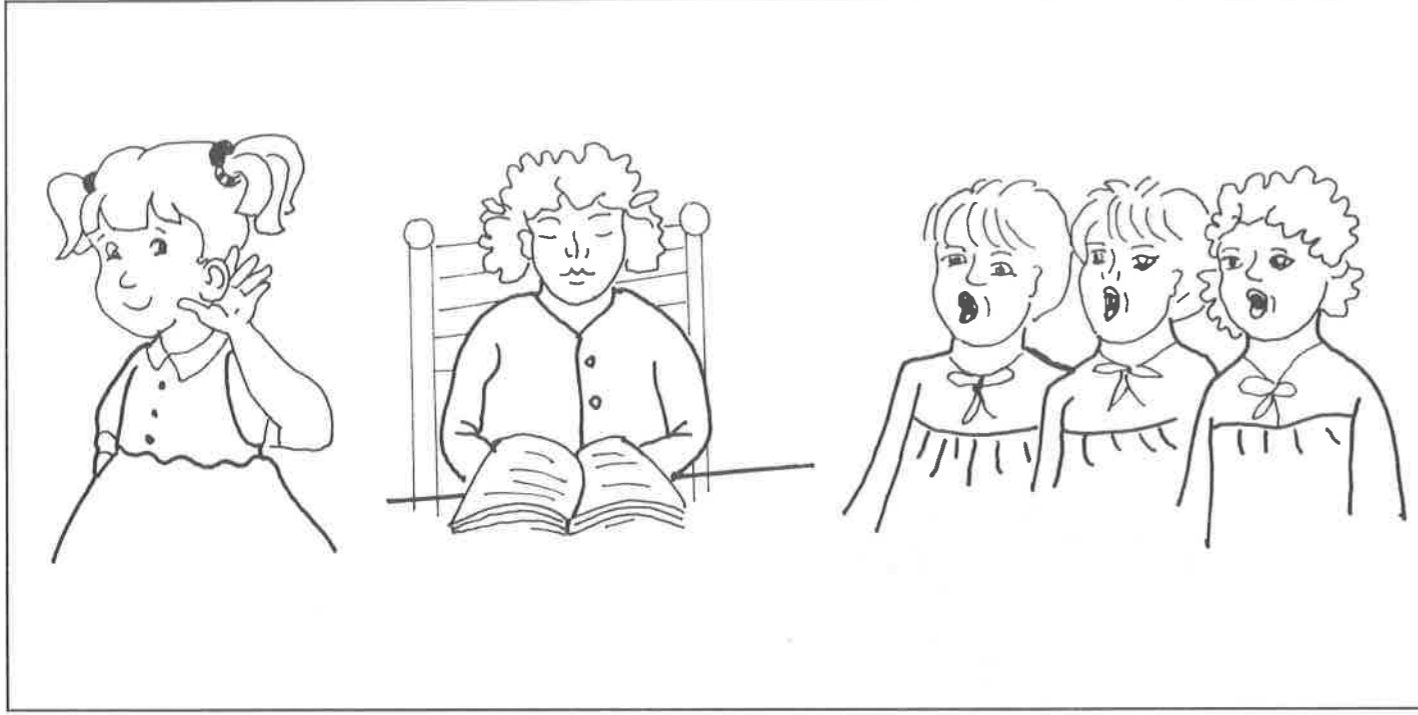

MÜZİK TESTİ: 22

Bu adam ne yapıyor?



MÜZİK TESTİ: 23

Kemanın yayı eksik, siz çizer misiniz?

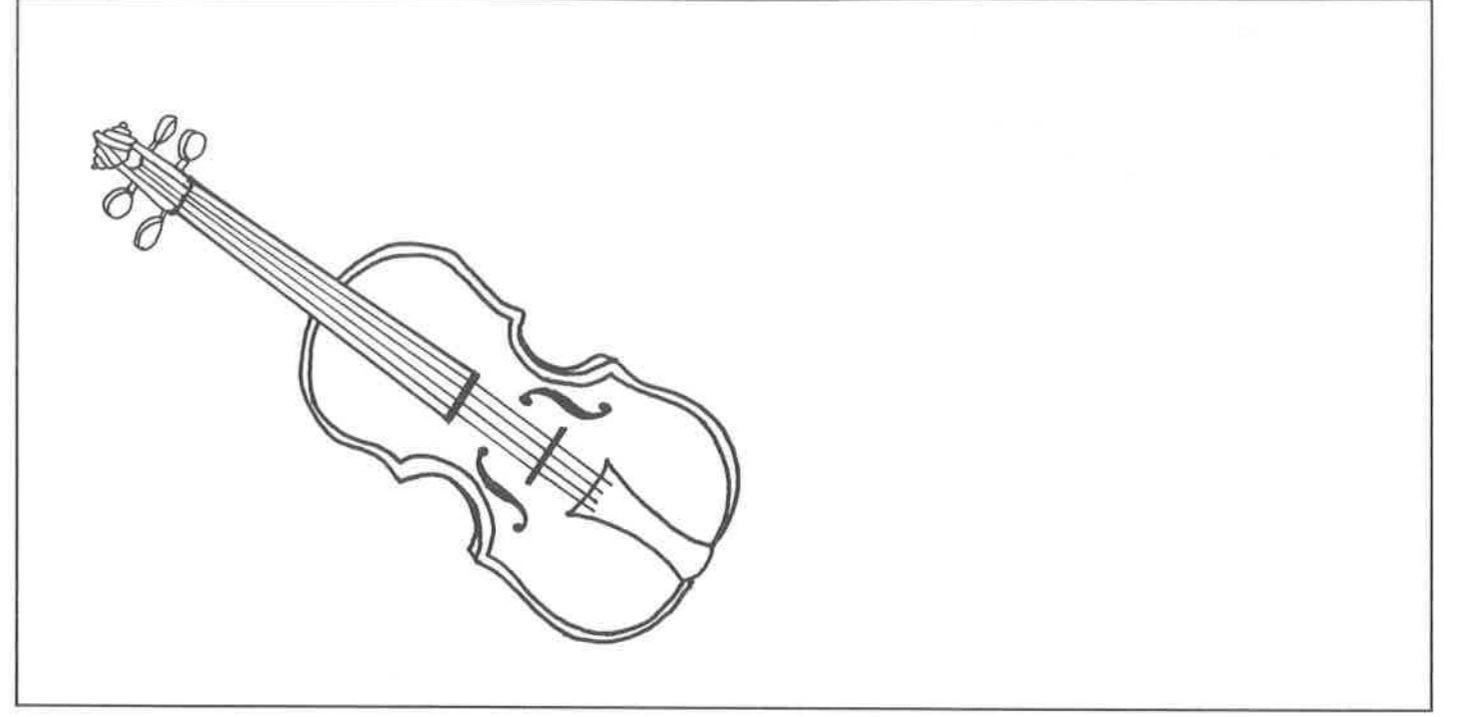

MÜZİK TESTİ: 24

Davulun tokmağı eksik, siz çizer misiniz? Davulu boyayalım.

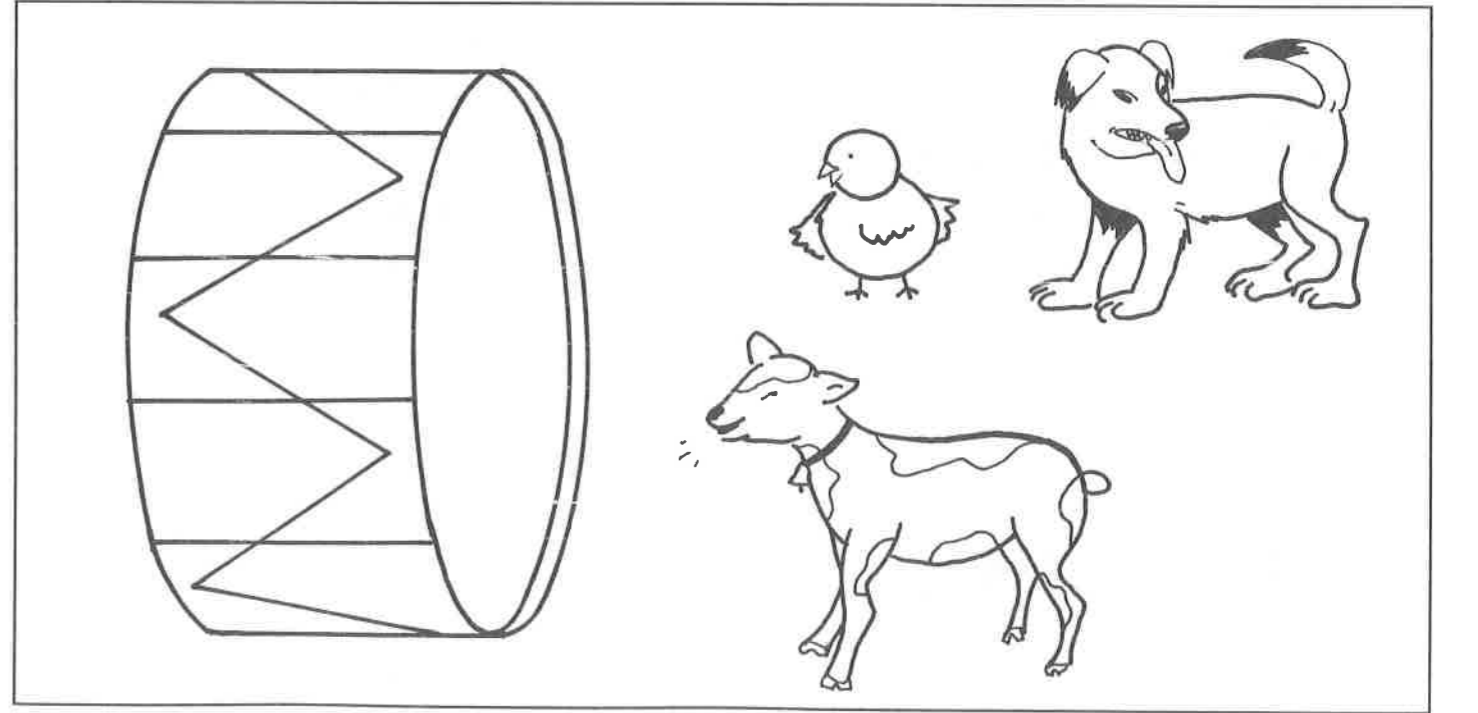

Bu davulun içinde hangi hayvan var? Resmini boya.

Bu resimler hangi şarkıyı hatırlatıyor? Söyle ve boy.

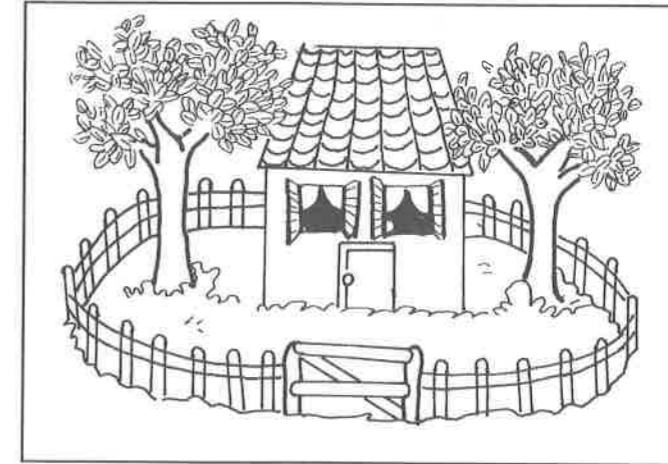
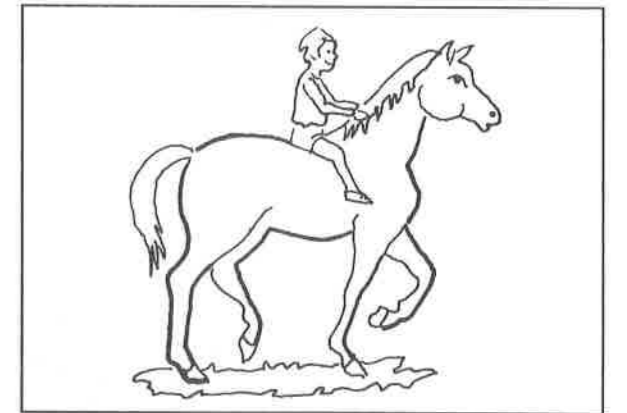
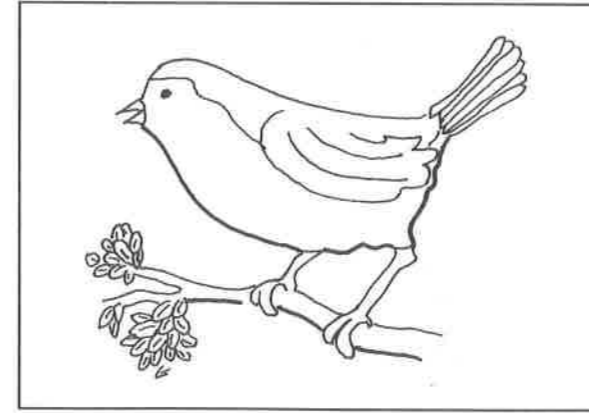
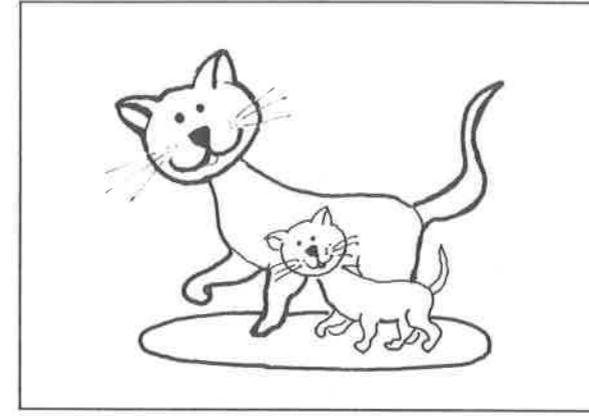
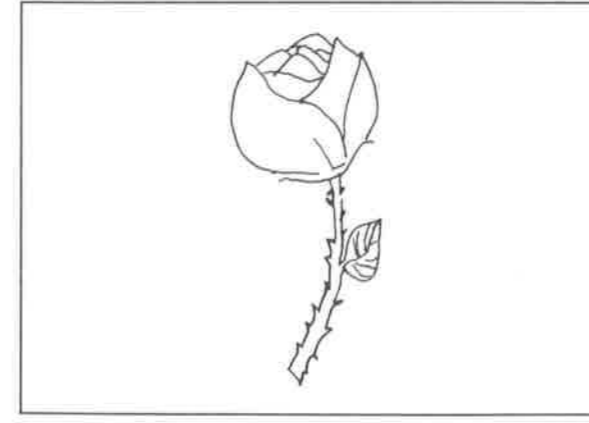
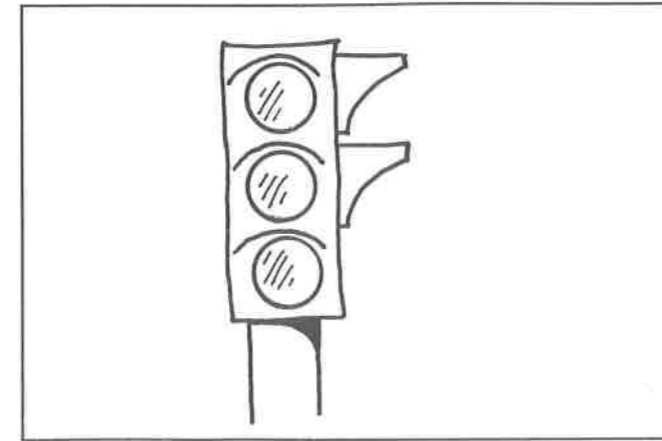
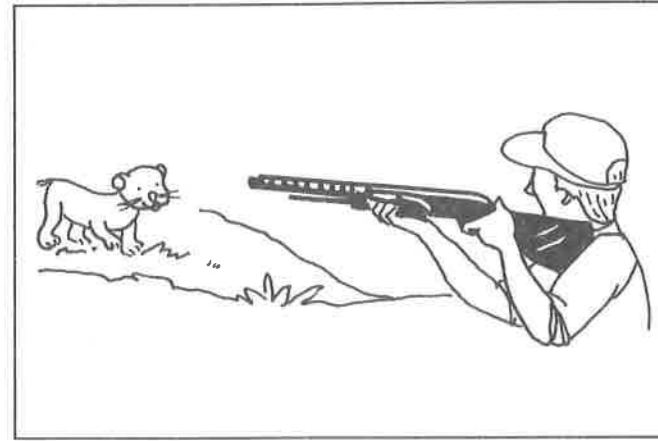
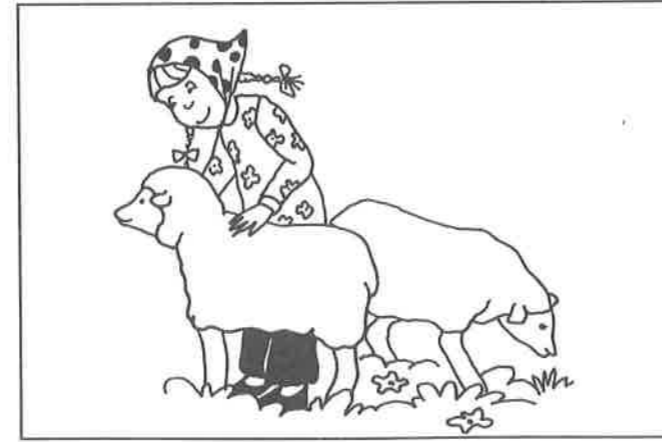
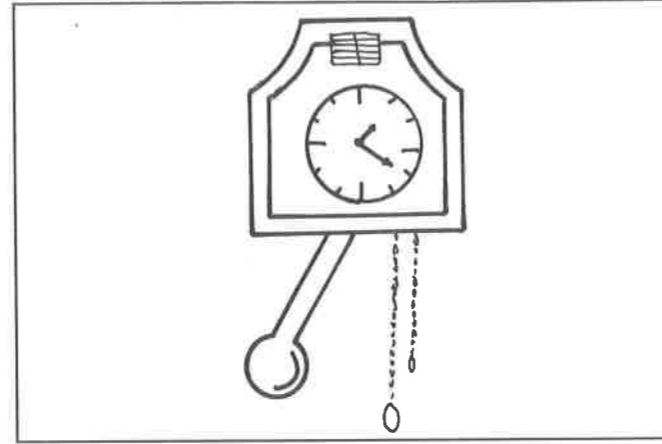
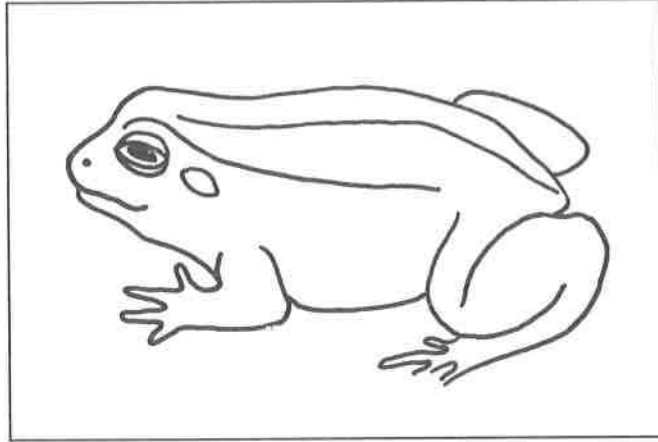
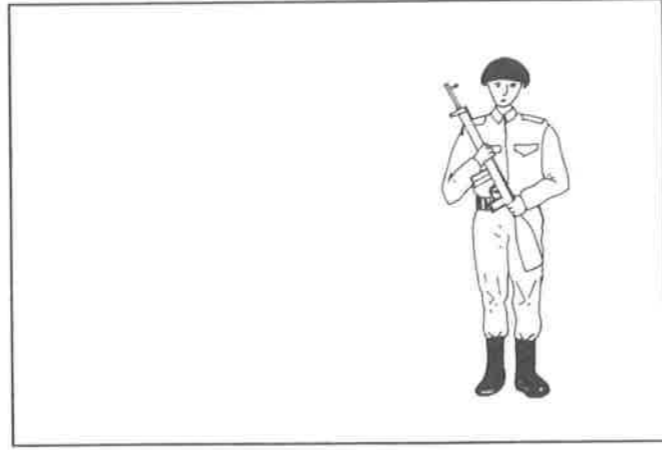
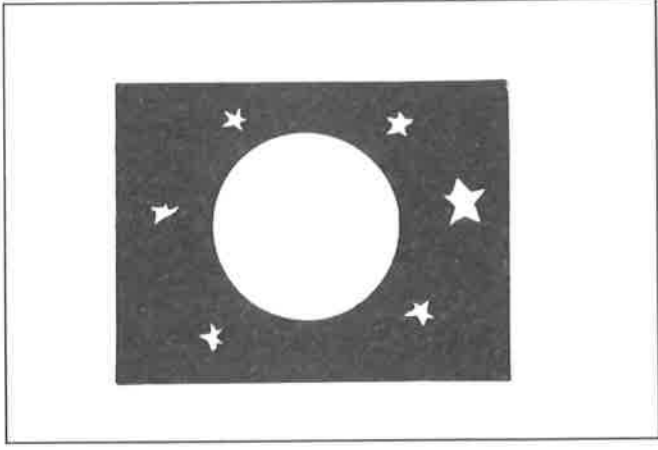

EK TEST : 1

Sesi aşağıda gördüğünüz çizgi gibi olan hayvan hangisidir?
Boya.

Git git gıdak

Git git gıdak

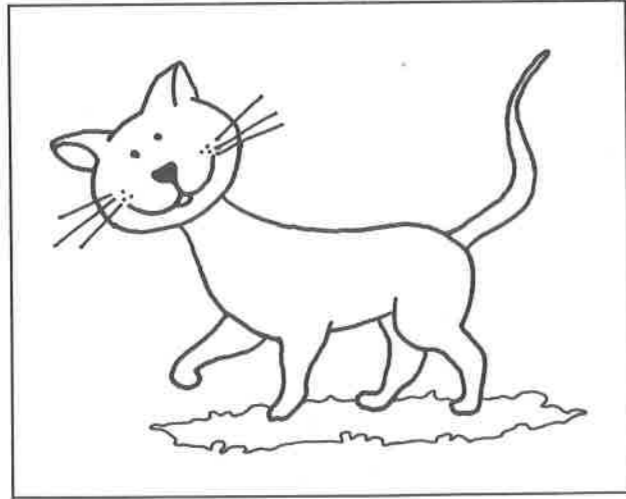
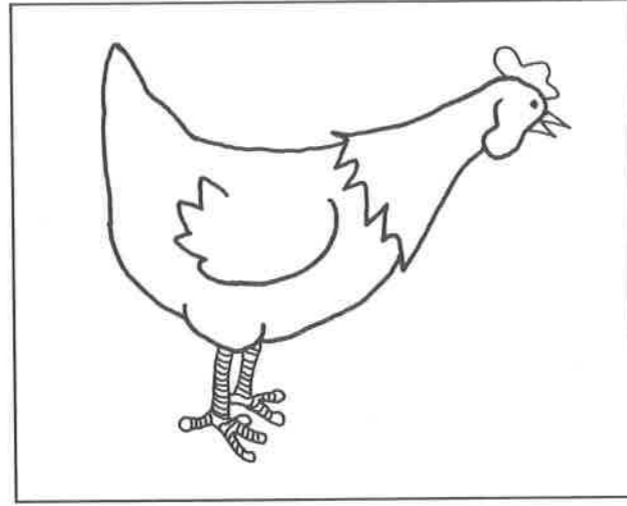
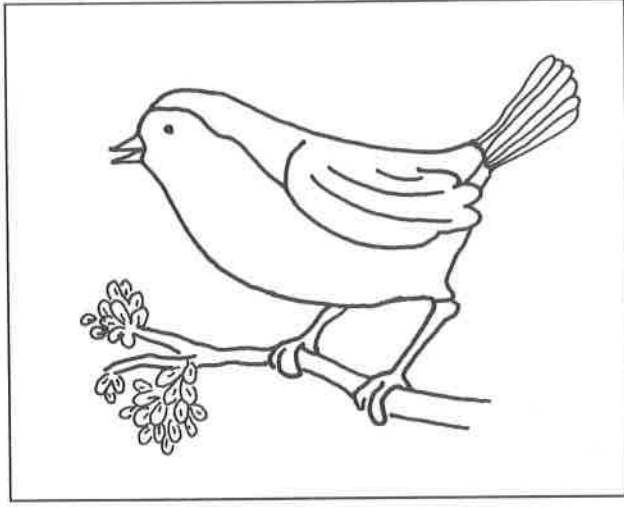

EK TEST : 2

Aşağıdaki hayvanların sesini çıkart,
çıkardığın sesi elinle havada çiz,
sonra resimdeki çizgileriyle ilgili hayvanı eşleştir.

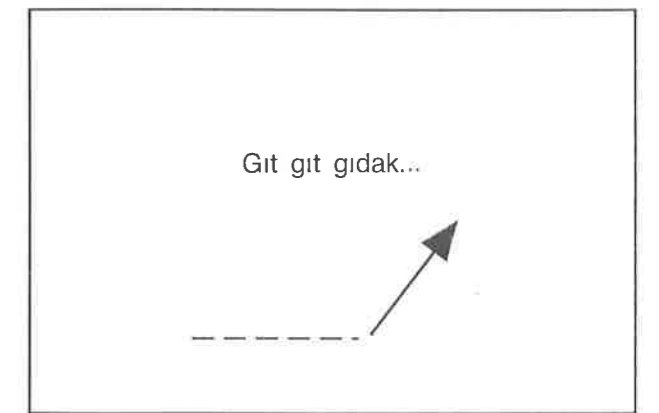
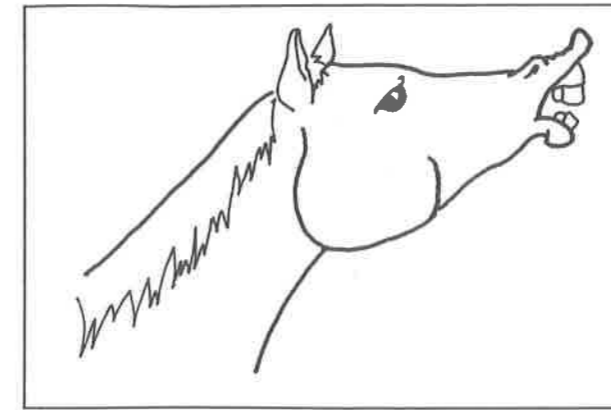
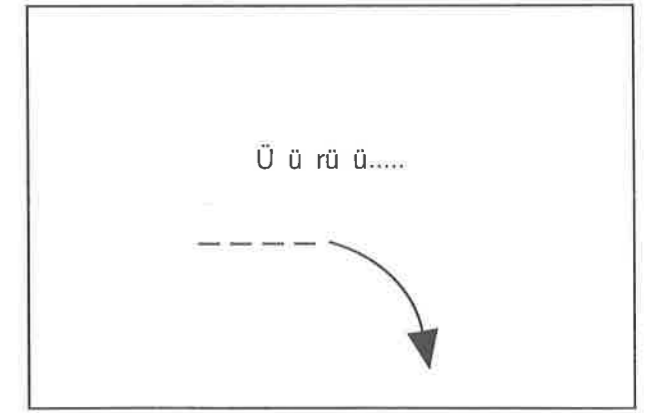
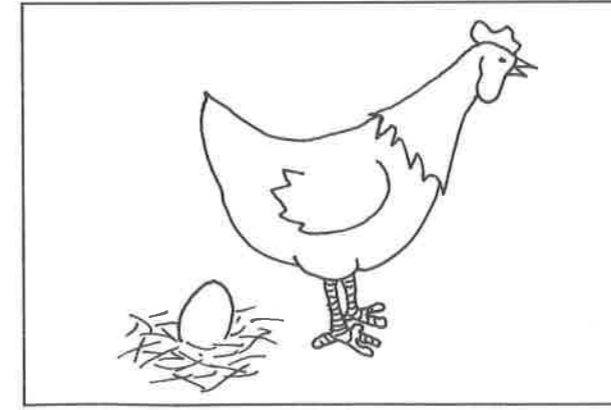
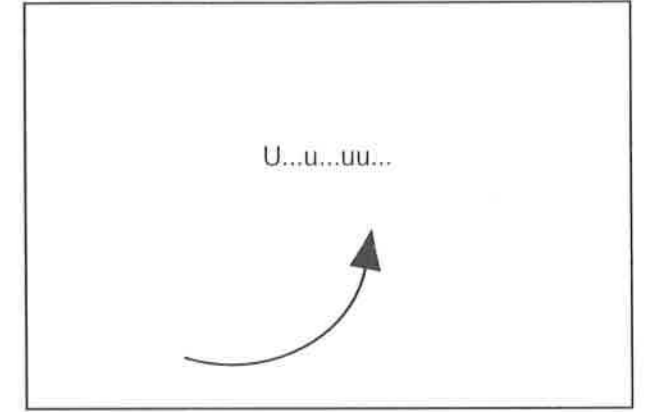
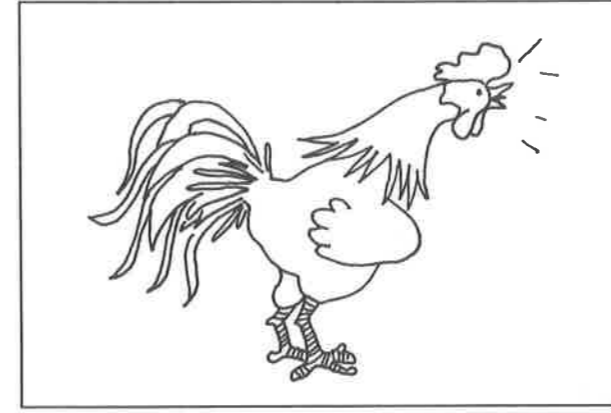
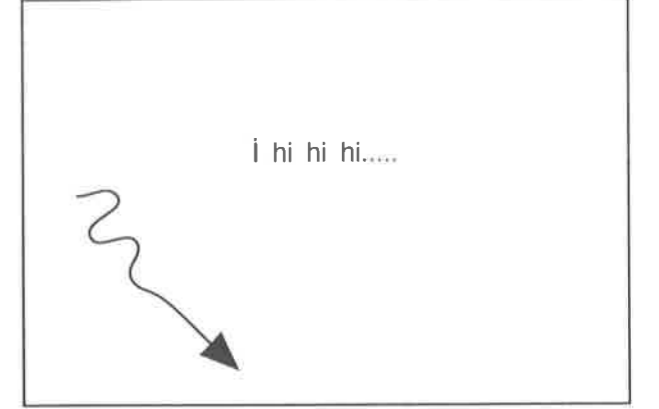
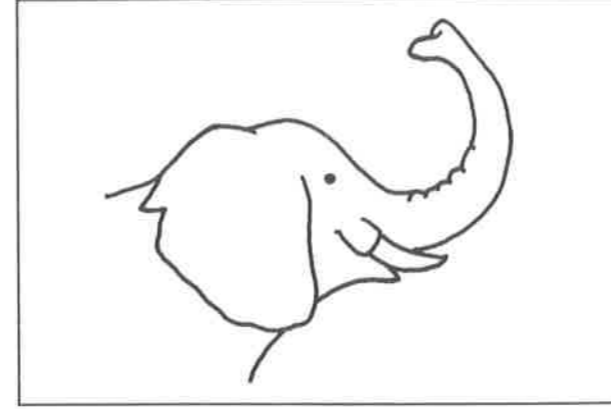

EK TEST: 3

A ve İ noktalarını birleştirirken eşeğin sesini çizelim,
çizerken sesini çıkaralım.

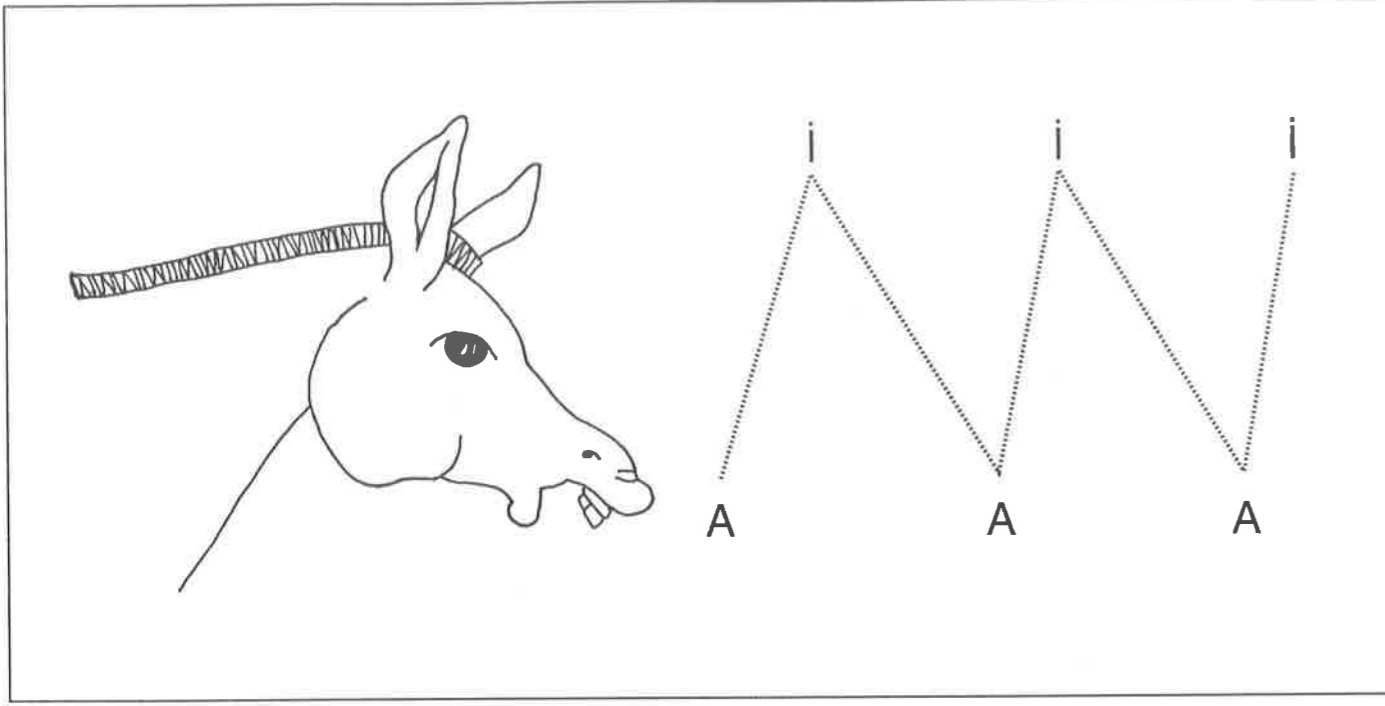

Anırma sesini elinle havada gösterebilir misin?

MÜZİK TESTİ: 20

NU ve Nİ noktalarını birleştirirken ambülansın sesini çizelim,
çizerken sesini çıkaralım.

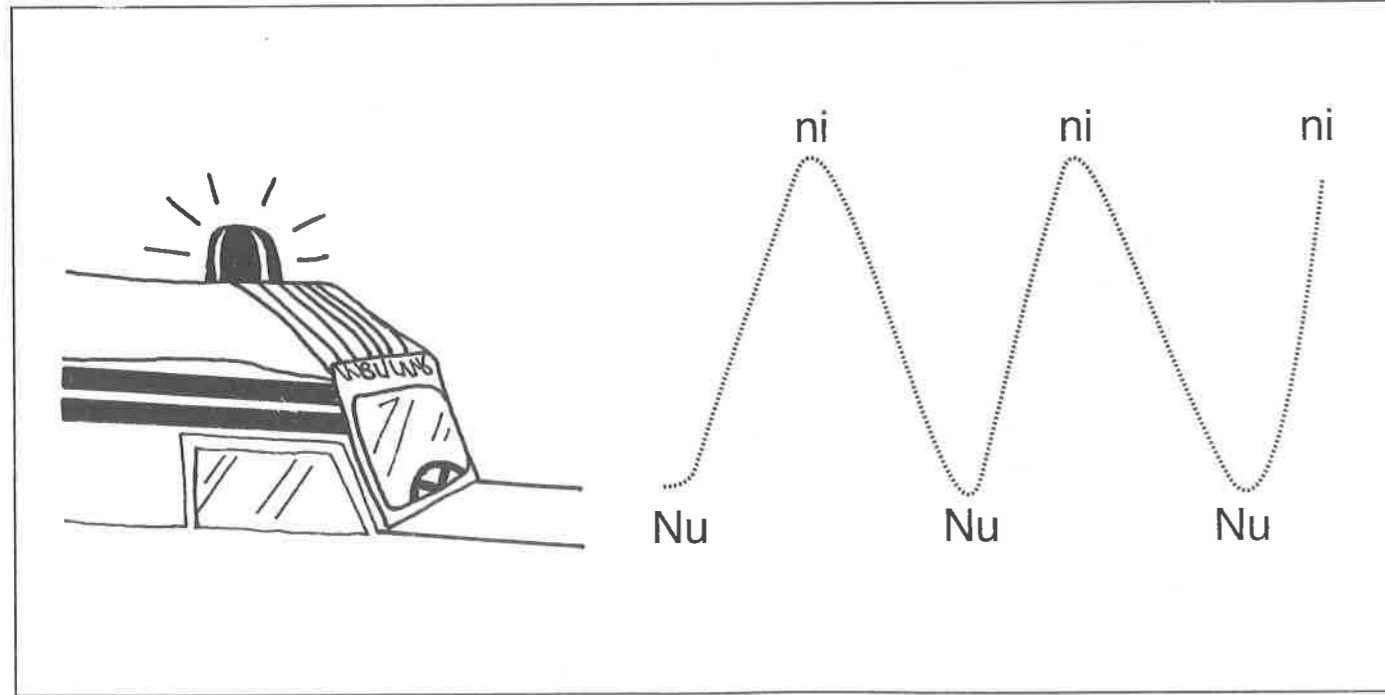

Ambülans sesini elinle havada çizer misin?